

see all the
things your
new

Kirby[®] Classic Ω [™]

can do...
in the
following
pages...



SPRAY GUN. Sprays lacquer, paint, insecticide, liquid floor polish, plus many other liquids.



HANDI-BUTLER. A versatile power tool for grinding, sharpening, buffing, and polishing. A flexible shaft lets you take the tool to the job.

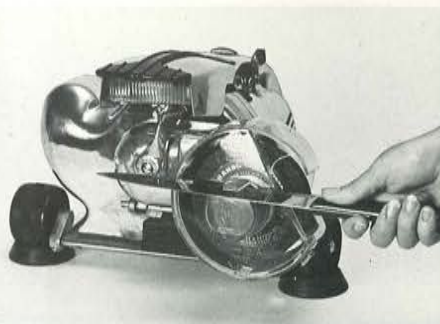

TANK TYPE CLEANER. Plenty of air flow and suction for dustless cleaning above the floor, with Utility Air Nozzle, Utility Brush Nozzle, Surface Nozzle, Duster Brush and Crevice Tool.



no other single appliance in the



CRYSTALATOR. A complete demisting unit. Gives you a quick, easy, safe, and sure method of dispensing para-crystals.



SUDS-O-GUN. Generates volumes of extra dry suds, when used with Kirby Instant Suds, for the safe, efficient, and economical shampooing of upholstered furniture.



MIRACLE WAXER. Applies Kirby Creme Wax to your hard surfaced floors with ease, and enables you to keep hard surface floors bright and new looking.

HAND PORTABLE. Deep cleans mattresses thoroughly, right on your bed. Wonderful for use on upholstered furniture, too.



UPRIGHT CLEANER. Exclusive "Triple Cushion Vibration" plus the widest nozzle of any in-the-home cleaner gets the job done faster. More leisure time for you.



SHAG KING. Cleans and combs shag rugs and carpeting with both the forward and backward movement of the Kirby Classic Omega.



world does as many things for you...



MIRACLE HEAD. Polishes all hard surfaced floors right up to the baseboard and into corners without leaving unsightly streaks or swirls.



RUG RENOVATOR. Shampoos rugs and carpeting safely, and economically. Ground-in dirt, soil, and lint are efficiently removed as you shampoo with almost dry Kirby Instant Suds.



Kirby®

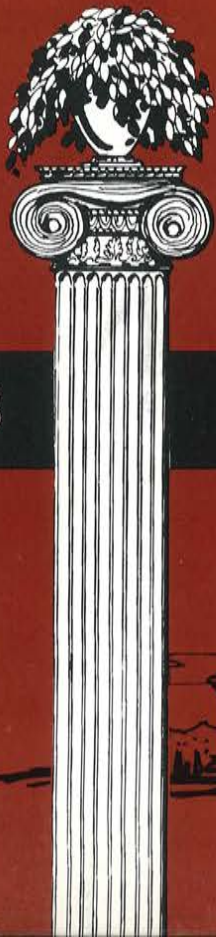

Classic Ω™

PLUS

BENEFITS

FLOOR DUSTER-BUFFER. Dual heavy felt pads loosen dirt and buff hard surfaced floors easily and effectively as you vacuum. May be used on Rug Nozzle or Surface Nozzle.



no other single appli



SHOULDER PORTABLE. Add the shoulder strap to the hand portable and you have a unit which frees both hands for cleaning in difficult places.

TOE TOUCH CONTROL. Gives you eight position adjustments to assure you the correct nozzle heights for all floor coverings, including deep shag textures.

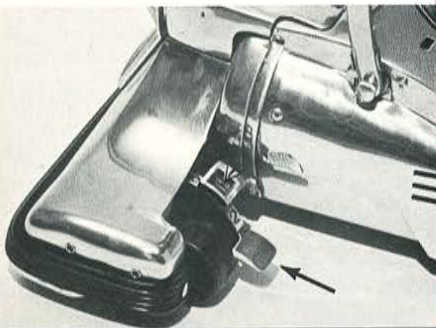

ATTACHMENT CASE. Designed for your convenience in use and storage. Hung on a door knob or closet hook—tools are handy for use. There's an easily identified place for all your Kirby attachments in this container.



SANI EM-TOR Only Kirby has Sani Em-Tor to save you money, and make emptying the filter bag fast and easy.



ance is as versatile or provides so many benefits . . .



SANI-POCKET. (Patented) Permits you to scrape excess dirt from the filter bag into the Sani Em-Tor without touching dirt.

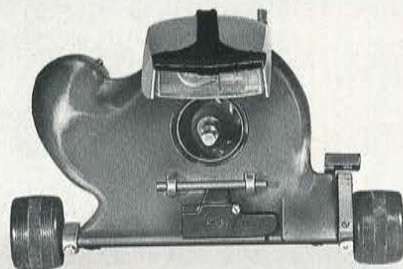

SAFETY SPEED SELECTOR SWITCH. For maximum operating efficiency and protection against possible injury, it automatically selects proper speed when attachments are on and avoids operation when fan is exposed.



SWIVELED CORD HOOK. Permits you to release the power cord for use simply by turning the cord hook.

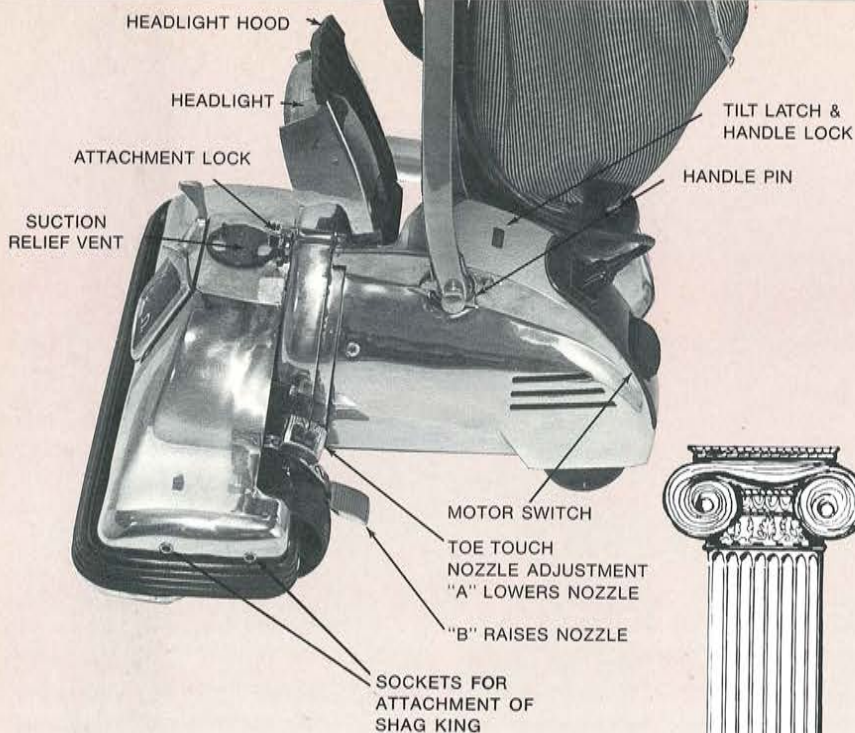

**for your
complete enjoyment
know your
KIRBY parts**

1. FILTER BAG
2. FILTER BAG GUARD
3. SANI EM-TOR
4. FLOOR DUSTER PAD
5. LONG HANDLE
6. BELT
7. BRUSH ROLL
8. BELT LIFTER
9. SUCTION RELIEF VENT
10. RUG NOZZLE
11. PORTABLE HANDLE
12. HANDI-SHARPENER
13. HANDI-BUTLER
14. SHOULDER STRAP
15. HANDLE PIN
16. MIRACLE HEAD
17. CORD
18. FLEXIBLE SHAFT
19. MOTOR UNIT
20. CREVICE TOOL BRUSH
21. DUSTER BRUSH
22. MASSAGE CUP
23. UTILITY BRUSH NOZZLE
24. UTILITY AIR NOZZLE
25. CRYSTALATOR
26. SURFACE NOZZLE—SWIVEL ATTACHMENT
27. CREVICE TOOL
28. STRAIGHT EXTENSION TUBE
29. CURVED EXTENSION TUBE
30. SPRAY GUN
31. HOSE COUPLER
32. FLEXIBLE HOSE
33. SWIVELED COUPLER TUBE
34. RUG RENOVATOR
35. MIRACLE WAXER
36. SHAG KING
37. SUDS-O-GUN CAP

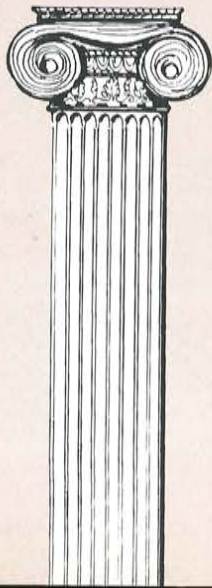

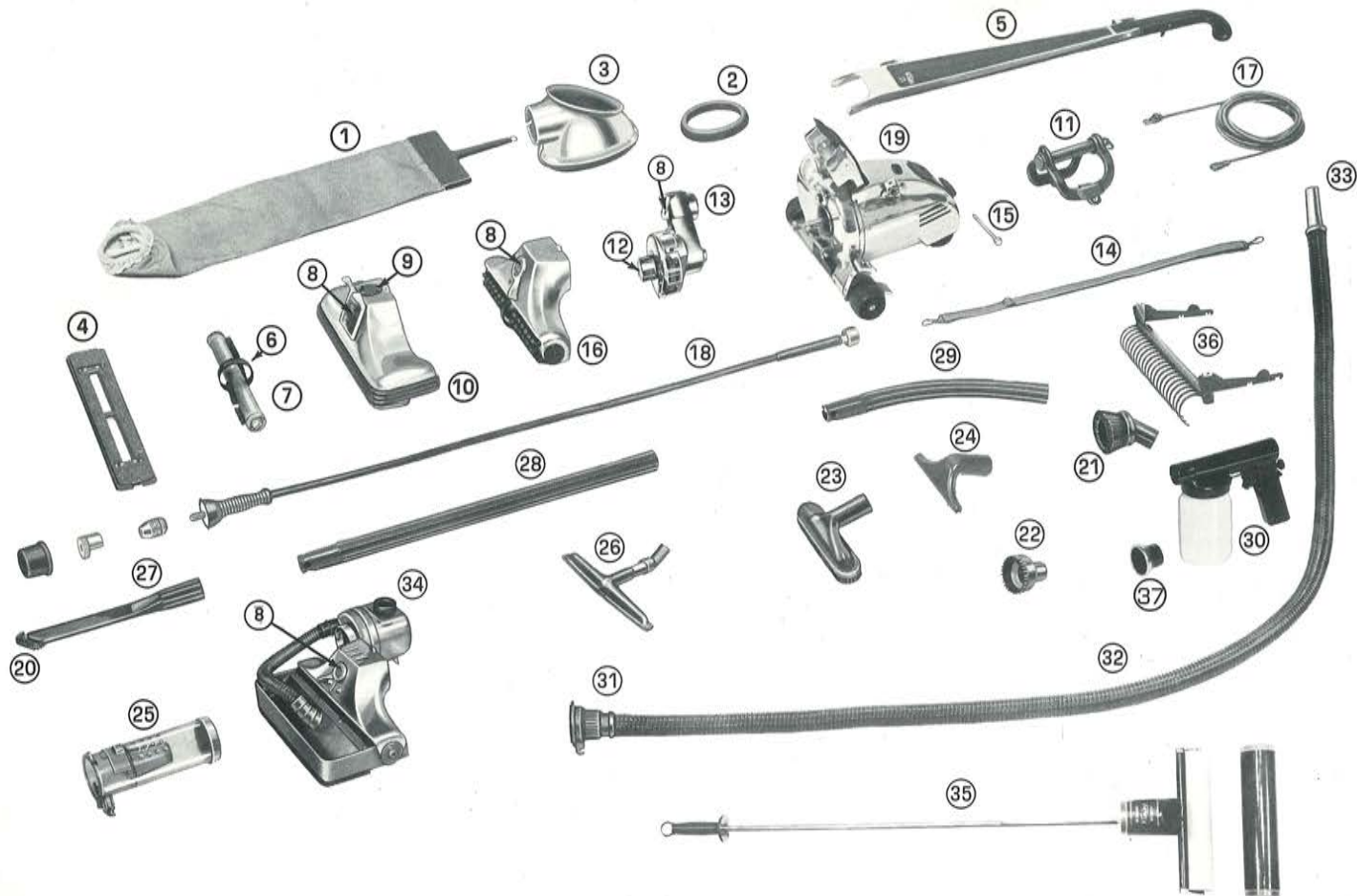

MAGIC FINGER belt lifter

FOR EASY CHANGING OF UNITS

The "magic finger" belt lifter makes it easy for you to change from use of the Rug Nozzle (Fig. 1), Miracle Head (Fig. 3) and Handi-Butler (Fig. 4). The belt transfers power from the motor to the Kirby unit. To change units, the belt must be removed from the belt drive shaft (motor pulley). The unit to be used is placed on the motor, and the belt lowered onto the belt drive shaft. The belt lifter raises and lowers the belt for you without you having to touch the belt.

Be sure Kirby motor and fan have stopped before changing units. It is recommended that the cord be pulled from the electrical socket to assure no mishaps.

BELT LIFTER DIAL

The belt lifter on the Rug Nozzle has

an indicating dial which shows you the position of the "magic finger". When the belt lifter is in the normal position for operating the cleaner, the words "BELT IS ON" appear in the window. (Fig. 1) When you rotate the belt lifter counter clockwise, the arrows indicate the direction to turn until the belt lifter comes to a stop (Fig. 2). At this position the words, "Belt Is Off" appear in the window. The belt is now removed from the motor pulley allowing the Rug Nozzle to be removed from the motor unit.

The belt lifter on the Miracle Head (Fig. 3) is in the "on" position when the wording on the label is right side up. The words "on" and "off" are shown on the Handi-Butler body to indicate whether the belt is "on" or "off" the pulley.

FIG. 1



FIG. 2



FIG. 3



FIG. 4

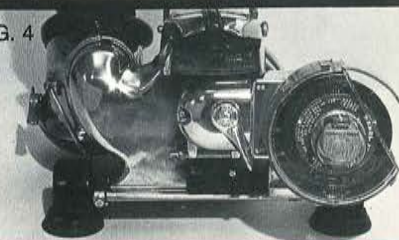

how to use the TOE TOUCH CONTROL

The exclusive Kirby Toe Touch Control enables you to adjust the rug cleaning nozzle to the proper height for efficient cleaning of all floor coverings from the thickest to the thinnest.

If the nozzle is too high above the floor covering, the air will enter the nozzle above the surface to be cleaned. If the nozzle is set too low, the air cannot get into the nozzle. In either instance, the cleaning action will be impaired. It is important to have the nozzle position just right for each thickness of floor covering.

To adjust the Kirby rug nozzle properly for your rug, simply depress the large lever (see "B" in illustration) with your toe as far as it will go.

This raises the nozzle to the maximum height and the pointer will indicate number 8 on the adjustment indicator when viewed through the opening in Lever "A".

Now turn on the motor and depress button "A" with your toe. Each time

you depress this button, the nozzle will lower one notch. Continue to depress this button one notch at a time until you notice a change in the sound of your Kirby. This indicates that the nozzle is at the correct level for the thorough cleaning of your carpet.

If the suction is broken with normal movement of the Kirby, lower the nozzle one more notch.

This same adjustment is used when operating the Hand Portable, the Miracle Head or the Rug Renovator. The Toe Touch Control also enables you to raise the front of the cleaner for ease of changing units.



Tilt Latch

Handle Lock

Motor Switch



TILT LATCH

This latch permits the long handle to swing in an arc to a point where additional downward pressure raises the rug nozzle up and over the edge of rugs, electric cords, and other obstructions. This action is accomplished by sliding the Tilt Latch Button toward the Toe Touch Control side of the Kirby as far as it will go.

When it is necessary to operate the Kirby under low furniture, the handle can be brought to a horizontal position simply by sliding the Tilt Latch Button to the extreme opposite position—toward the bag and Sani Em-Tor.

HANDLE LOCK

To lock the handle in the horizontal position for storage in small

areas, simply push the Tilt Latch Button toward the Toe Touch Control side of the Kirby while the handle is in the horizontal position. It may be necessary to maintain pressure on the cleaner as you gradually raise the handle.

MOTOR SWITCH

The Kirby motor is turned on or off by depressing the large push button switch located just above the rear wheels with either your toe or hand. Most Kirby owners find the easiest way is to simply raise the toe of one foot and pull the Kirby back until the toe touches the switch button.



how to use the **SANI EM-TOR** **AND** **SANI-POCKET**

The Sani Em-Tor, and the patented Sani-Pocket, is found only on the Kirby. They enable you to empty the bag right in your home without muss, fuss, or expense. Because your Kirby picks up more dirt, the Sani Em-Tor should be emptied after each thorough cleaning. If dirt is allowed to accumulate in the filter bag, the cleaning efficiency of your Kirby will be reduced.

EMPTYING THE FILTER BAG

1. Spread newspaper on the floor and place Kirby on it.
2. Detach wire loop on top end of bag from handle hook.
3. Lower rug nozzle to No. 1 position (see page 9) and turn on motor.
4. Allow motor to run briefly and then turn off. While bag is still extended, shake it vigorously from the top.
5. Tilt Kirby slightly and rotate side lever fully to release bottom cover of Sani Em-Tor. In the "open" position the lever will point to the rear of the Kirby.
6. Swing cover out from under Sani Em-Tor and turn it upside down, emptying the dirt and lint onto the paper. The cover will stay in this position while the bag is being cleaned.
7. After all dirt has been removed, swing cover back into place and lock securely with locking lever. Make sure that lever handle is **fully** rotated.

(If excessive dirt and lint has accumulated in the bag, and does not fall readily into the Sani Em-Tor use the following procedure.)

1. Open zipper at rear of bag and place hand into patented Sani-Pocket, grasping Sani-Scraper at bottom.
2. Scrape sides of bag with Sani-Scraper in downward strokes.
3. Using Sani-Scraper, push excess lint and dirt into Sani Em-Tor.
4. Empty as in "5" through "7" above.



attachment instructions on **HANDI- BUTLER**

On the front of your Handi-Butler you will find a lever which can be rotated between "ON" and "OFF" positions. This is the belt lifter for the Handi-Butler.

STEP 1. Set the lever in the "ON" position and by looking through the round opening at the back, make sure the belt is over the metal finger. If it is not in place, use a lever such as a screwdriver to slip the belt over the finger.

FIG. 1



FIG. 2

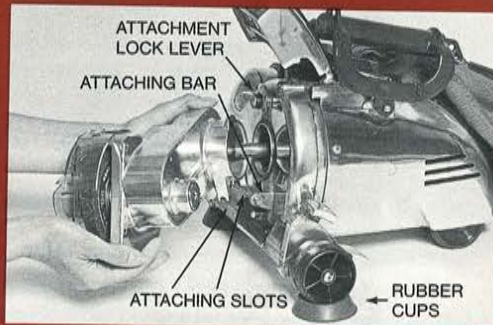
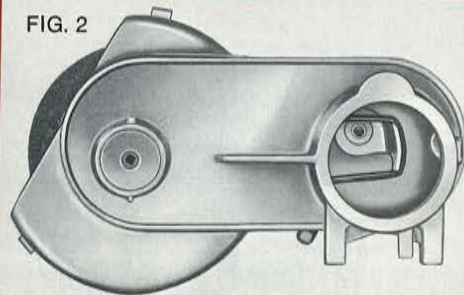

FIG. 4



STEP 2. Turn the Belt Lifter Lever to the "OFF" position thus extending the belt (Figure 2). The unit is now ready for attachment to the motor unit.

STEP 3. Raise the Headlight Hood. Hold the Handi-Butler so the attaching slot is on the attaching bar which is just below the belt drive shaft or motor pulley. (Figure 3). The belt drive shaft should enter the large round

opening and pass through the loop formed by the belt.

STEP 4. Swing the unit back against the Kirby; and at the same time, press the attaching slots of the Handi-Butler on the attaching bar of the Kirby. While holding the unit in place, turn the attachment lock lever to hold the unit firmly. (Figure 4).

STEP 5. Turn the Belt Lifter Lever to the

"ON" position and the unit is ready for operation. Rubber cups, which are provided, should be placed under the front wheels to steady the unit (Figure 3). When using the grinding wheel, look through the eye shield part of the transparent grinding wheel cover to help protect your eyes. Safety glasses are recommended when using the wire brush, sanding disc or grinding wheels.

how to use the HANDI-BUTLER

THE ASSEMBLY OF WORK WHEELS

The Grinding Wheel, Wire Brush, and Buffing Wheels may be attached to either the Handi-Butler itself, or the flexible shaft. The Sanding Disc and Polishing Pad will attach to the flexible shaft only. To attach to the Handi-Butler, grasp the wheel by the finger grip and insert the wheel shaft into the drive shaft opening. The magnetic clutch will hold the wheel firmly in place. To remove, grasp the wheel by the finger grip and pull firmly away from the drive shaft. To attach the drill chuck, insert the wheel shaft into the drill chuck and tighten. It is not necessary to use pliers or a wrench when tightening or loosening the chuck. Simply press the small shaft locking button into one of the slots in the flexible shaft handle face plate. This holds the shaft, while tightening or loosening the chuck, as a wrench would. The drawings on the right show typical assemblies, and in the case of the work wheels, the same sequence is followed with each.

ATTACHMENT OF FLEXIBLE SHAFT

To attach the Flexible Shaft, grasp the knurled collar of the bayonet connection and insert the core wire into the small hole at the rear of the Handi-Butler housing. Align the slots in the collar with the pins on the housing and with a firm forward pressure, twist to the right. When released the connection will lock firmly in place.

A slight rotation of the Handi-Butler drive shaft may be needed to permit the core wire to engage with the drive shaft. Caution should be taken to be sure the hand grip of the shaft is held in the hand whenever the power is on.

When using the Flexible Shaft, make certain the Wheel

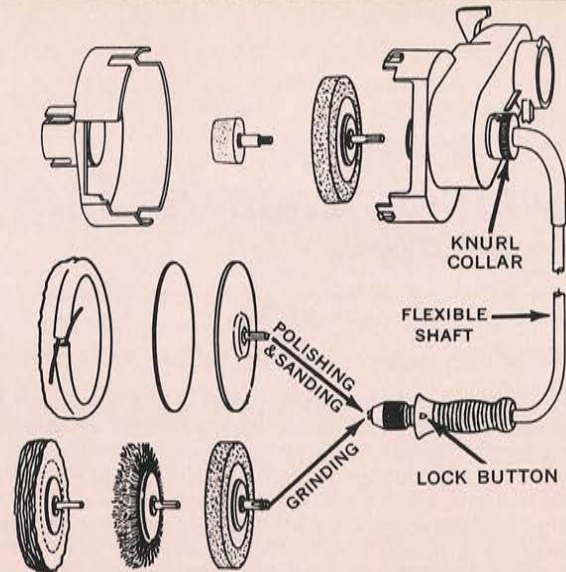

Guard Cover is in the proper position so as to cover any work wheels on the Handi-Butler and thereby eliminate the possibility of accidental contact.

WHEEL GUARD COVER

The Wheel Guard Cover attaches to the Handi-Butler by sliding the open edge into the spring clips on the Handi-Butler. An eye shield portion of this transparent part extends downward around the wheel opening to protect against injury from small particles thrown off the wheel when grinding or wire brushing.

Caution! The flexible shaft is designed for use only on the Kirby Handi Butler. Grinding and wire wheels used on all power extension shafts revolve at very high speeds—caution should be used in their operation. Wear safety glasses.

how to use your **SWEDISH MASSAGE UNIT**

U. S. Pat. 3,735,757

The Kirby Swedish Massage Unit puts magic in your fingertips. It provides the controlled, rotating, patting movements which enable you to give a gentle, pleasant, and soothing Swedish-type massage.

To use the Massage Unit, simply remove the chuck from the Flexible Shaft, and turn on the metal eccentric weight part included in the Handi-Butler box. Snap the plastic cover over the eccentric weight by pressing the open end on to the Flexible Shaft Handle. Attach Flexible Shaft to Handi-Butler as outlined on page 13 and with the Handi-Butler on the motor unit your Massage Unit is now ready for use.

Hold the Flexible Shaft Handle in the normal position in your right or left hand with the thumb and forefinger next to the large end of the handle. Curl the thumb around the handle, but leave the fingers free to contact the surface to be massaged.

When you turn on the Kirby motor unit, you'll feel a vigorous, but gentle vibration through your fingers. As with all massage units, the vibration is to be transmitted only through the fingers. Using it in this manner, you control the action to a pleasant and soothing degree. Take your time. Do not dig in with the fingers.

You'll find the Kirby Massage Unit much easier to use than other devices, since it is not necessary to support the weight of the motor when using it.

Massage can be applied in a wide variety of ways, some of which are as follows:



GENERAL MESSAGE. Use on arms, chest, legs, abdomen, and back.

SCALP MESSAGE. Apply to all areas of the scalp by supporting the head against the pressure of the massage with the free hand. Especially soothing to the back of the neck as your barber does.

FACIAL MESSAGE. Apply after cold cream, using the fingers of the free hand to draw the skin taut as necessary. Avoid contact with sensitive areas, such as around the eyes.

FOOT MESSAGE. Use at heel, bottom of foot, and toes for complete results. You will find stroking, kneading, rotating, and patting movements to relax tired muscles.

CAUTION: Do not use massage on any areas that are swollen, inflamed, painful, covered with skin eruptions, or on varicose veins, unless you consult your physician first.

Be sure the hand grip of the Swedish Massage Unit is held in the hand when Kirby motor unit is on.

Be sure cover of Swedish Massage Unit is securely in place. Do not operate or use Massage Unit without cover.

how to use the HANDI-SHARPENER

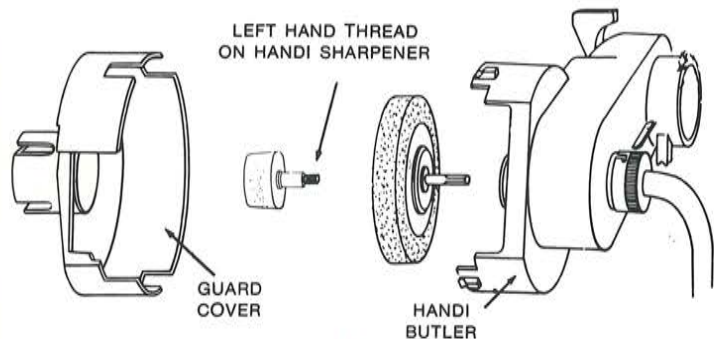

HANDI-SHARPENER

Your Handi-Sharpener is assembled and ready to use when you receive it. If it becomes necessary to replace the Knife Sharpening Wheel, simply unscrew it from the Grinding Wheel. Replacement wheels can be obtained from your Kirby dealer.

The preferred method of sharpening a knife is as follows: Remove the Plastic Wheel Guard, rotate 180° and replace. The rim of the Plastic Wheel Guard will cover the large Grinding Wheel and eliminate the possibility of accidental contact. Hold the knife to be sharpened in your right hand, using the left hand to assist in steadying the knife handle. Insert the knife blade at the handle end into the top slot and guide it back and forth, keeping the edge of the blade against the Grinding Wheel. Now sharpen the other side of the knife by inserting the blade into the bottom slot and repeating the operation.

POLISHING AND BUFFING

The Polishing Pad is stretched over the rubber disk and fastened by drawing the strings tight and tying. Be sure to tuck the loose ends under the edge of the pad. This pad is ideal for polishing waxed surfaces such as your table tops, shoes, and automobile.

Your Buffing Wheels can help you restore the luster to your silverware or other decorative metal objects around your home. The Sheeting Buffing Wheel is used with the red polishing compound No. 1 to polish brass, copper, or similar metals. The Flannel Buffing Wheel is used with the light-colored polishing compound No. 2 to polish precious metals such as gold or silver. The polishing compounds are applied by holding the stick against the rotating wheel.

Compounds contain oils, grease and abrasive materials. Keep out of reach of children. Wear safety glasses.



WHEEL CUPS
Place under front wheels of motor unit.



SHEETING BUFFING WHEEL
Use with red polishing compound No. 1 on metals such as brass or copper.



POLISHING COMPOUNDS
Store in cool place. See directions on wrapper.



GRINDING WHEEL
Do not use if chipped or cracked. Wear safety glasses to protect your eyes when using this wheel.



FLANNEL BUFFING WHEEL
Used with light colored polishing compound No. 2 on precious metals such as gold or silver.



WIRE BRUSH
Wear safety glasses to protect your eyes when using this versatile wheel.



SANDING DISKS
Attach to rubber disc for light sanding.



POLISHING PAD
For polishing waxed surfaces.

FIG. 1

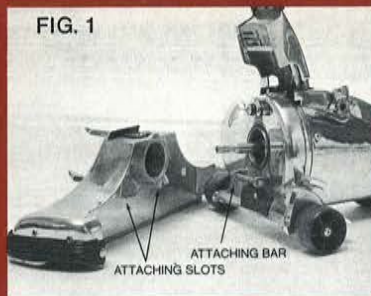

FIG. 2



FIG. 3



FIG. 4



ASSEMBLY INSTRUCTIONS

HANDLE ASSEMBLY SWIVEL CORD HOOK WRENCH

The long handle is in two pieces in the shipping box, and is usually assembled by your Kirby dealer at the time of purchase. Should you ever want to repack the cleaner in the box, disassemble the handle as follows:

Remove the handle from the Kirby by pulling out the Handle Fork Pin, and remove the cord. Grasp the top swivel cord hook in one hand and the handle in the other. Pull the cord hook away from the handle (against the spring). You will feel the notches in the cord hook hole engage the head of the attaching screw, like a wrench. Using the cord hook like a wrench, turn it counter clockwise about three turns; or if you wish, you may use a Phillips screwdriver in the "cross" slot provided in the attaching screw head. When you have done this, press down on the screw head with one hand and pull out the handle grip with the other. For re-assembly, simply push the grip part into the metal part until you hear the "snap", then tighten the screw firmly.

UPRIGHT CLEANER

The following units should be attached to the Motor Unit for use as an upright rug cleaner: Rug Nozzle, Long Handle, Sani Em-Tor and Bag.

ATTACHMENT OF RUG NOZZLE

STEP 1: Prepare Rug Nozzle for attachment by raising belt on Belt Lifter Finger. This is the "Belt is Off" position. (See page 8).

STEP 2: Set Toe-Touch Nozzle Adjustment at No. 8 position on adjustment scale. (See instructions on page 9). Raise Headlight Hood.

STEP 3: Place attaching slots at back of Rug Nozzle on the attaching bar. (See figures 1 and 2). Swing nozzle back toward motor unit with a slight downward pressure, so as to depress the Speed Selector Switch Arm (see figure 2). Hold nozzle in place with one hand and lock in place with Attachment Lock Lever at top-front of motor unit (See figure 3.)

STEP 4: Turn Belt Lifter to "ON" position (figure 4). To remove nozzle, reverse these steps. Be sure to have Belt Lifter in "OFF" position before releasing Attachment Lock Lever. (See figure 3.)

ATTACHMENT OF LONG HANDLE

STEP 1: Remove Handle Pin from motor unit by pulling straight out with a slight twisting action. (See figure 5).

STEP 2: Insert the fork on the Long Handle into the slide at top of motor unit.

STEP 3: Replace Handle Pin as far as it will go into both holes of the Handle Fork.

FIG. 5



HANDLE FORK PIN

FIG. 6



NECK COLLAR



FIG. 7

ATTACHMENT OF SANI EM-TOR

STEP 1: On the inside of the Sani Em-Tor Collar you will notice three curved slots. These should be lined up with the pins on the neck of the motor unit. (See figure 6.)

STEP 2: Slide the collar firmly over the neck and twist downward. The unit will lock firmly in place.

When the unit is new, the rubber gasket inside the collar of the Sani Em-Tor will be stiff and offer some resistance. This gasket is necessary to give you an air-tight seal.

To remove the Sani Em-Tor simply twist from the bottom and away from the motor unit. It will unlock with a snap.

ATTACHMENT OF CORD

Plug the cord into the rear of the motor unit just above the Switch Button. Fasten the grommet on the cord into the clip just below the Handle Grip and wind down under the lower cord hook and up over the top cord hook. Fasten the wire loop on the top of the bag to the hanging clip near the handle grip. Then, to keep the cord out of the way when the handle is lowered to the horizontal position, twist the cord under the two projecting hooks near the bottom of the handle rear cover in such a way as to allow the cord to move freely once it is under the hooks.

SUCTION RELIEF VENT

Turn vent plate clockwise to open. When open, it is easier to clean efficiently, long pile cotton or synthetic carpets and light weight throw rugs. Vent should be closed for normal, full power cleaning operations and when emptying bag. See page 6 for location. When the Suction Relief Vent is in the "Open" position, the Headlight Cap should **always** be all the way down against the Rug Nozzle.

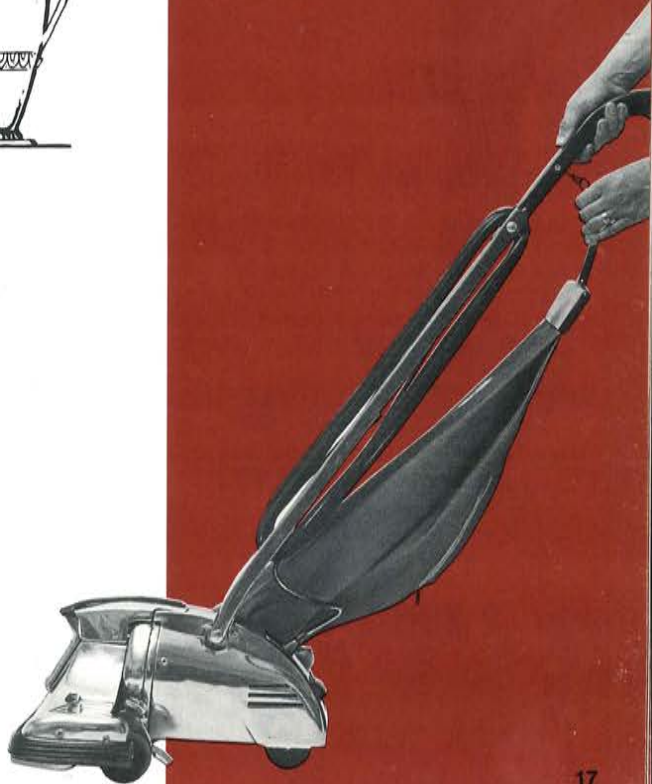



how to use the DUSTER-BUFFER

With the Kirby assembled as an upright rug cleaner snap the Floor Duster Pad into place by inserting the spring clips into the Rug Guard on the bottom of the Rug Nozzle. Lower the Rug Nozzle by using the Toe Touch control until the Floor Duster Pad rests firmly against the floor. Turn the Belt Lifter to "Belt Is Off" position, turn on the motor and you are ready to buff-dust hard surface floors. To remove excess dirt from the surface of the felt pads when you are through cleaning, simply remove the Floor Duster Pad, and using the Kirby as a tank type cleaner, run the utility air nozzle or crevice tool over surface of the felt pads. The Duster-Buffer also may be attached to the Surface Nozzle.

how to use the MIRACLE HEAD

Assemble the Kirby as an upright cleaner, (see pages 8, 16 and 17) with the exception of the Rug Nozzle. In its place, attach the Miracle Head Nozzle. Attachment procedure is the same as for the Rug Nozzle. (See page 16).

Apply wax to the surface to be protected following the instructions for the Miracle Waxer (see page 26). Set the Toe Touch Control to the lowest (No. 1) position. Set the handle in the normal cleaning position and hold it while you turn the motor on. Keep a firm grip on the handle to keep the cleaner from pulling away from you. The powerful brush of the Miracle Head will quickly polish your waxed floors to the highest possible luster.

To maintain the condition of your Miracle Head and receive the maximum benefits from it, use it for polishing floors on which you have used Kirby Creme Wax only.

The Miracle Head will neatly polish a cove molding or a six inch baseboard by pushing the handle down against the Tilt Latch (see page 10) which will raise the brush.

When storing the Miracle Head Nozzle, detach it from the Kirby, relieve the belt tension by turning the Belt Lifter around to unlock the belt which will avoid permanent stretching of the belt material. Stretching of the belt over a long time span may cause the belt to become lifeless and result in slippage.

how to use the **RUG RENOVATOR**

Before shampooing rugs or carpeting with the Rug Renovator, the entire area to be renovated must be thoroughly vacuumed using the Kirby Upright Unit.

ATTACHING RENOVATOR TRAY

Remove the Rug Nozzle, Sani Em-Tor, and bag from the Kirby. The Renovator Tray attaches to the nozzle assembly (Figure 1) by sliding the Renovator Tray into the slots at each end of the nozzle assembly. Turn the Belt Lifter to "OFF" position and attach the Renovator Nozzle to the front of the Kirby motor unit the same way you attached the Rug Nozzle. (See Upright assembly instruction page 16.)

Attach the Renovator Tank to the neck of the Kirby, as you did the Sani Em-Tor, making sure the sponge-like filter is in place. (See attachment of Sani Em-Tor page 17.)

Insert angle end of hose with the grommet fitting into the grommet hole in the Renovator Tray (see Fig. 1). Slip other end of the hose over the Tank Discharge Suds-O-Screen.

Using the tank cap as a measure, put 4 oz. of Kirby Instant Suds (two tank caps full) into the Renovator Tank, then add warm water to the "fill" line (1 quart). One tank full of solution should be sufficient to clean an area approximately 9 x 12 ft. If you plan to clean an area larger than this and need to refill the tank, it is recommended you first rinse any accumulated lint off the tray, hinged shelf and brush area.

ADJUSTING RENOVATOR

To adjust the Rug Renovator to the proper height for shampooing your rug or carpeting, depress the Toe Touch Control lever ("B" on page 6) as far as it will go. This raises the Rug Renovator to its maximum height. Lower the Rug Renovator a step at a time by depressing the Toe Touch Control (Lever "A" on page 6). Depress the Toe Touch Control as many times as it is necessary until the brush roll will just start to rotate as you move the Kirby back and forth observing the motion of the brush roll. You are now ready to begin the shampoo operation. Keep the control at this setting for your type of carpet. If different carpet is shampooed, repeat adjustment to get proper setting.

DEPOSITING SUDS

Start the Kirby motor. Shampoo suds will start to flow down the transparent hose through Renovator Tray to the rug. Push and pull the unit slowly back and forth with overlapping strokes. A layer of suds the entire width of the tray will be seen on the back stroke of the Rug Renovator if the height is properly adjusted. If suds accumulate in front of tray, move the unit faster; if width of suds left on rug is not as wide as the tray, move unit slower. The dirt and spent suds will be deposited in the tray, the rug surface will be slightly damp after shampooing, and some residual light suds may remain. Rug Protector Pads furnished must be placed under all legs of furniture to protect against rust stains.

When the surface has become dry, the residue will turn to a dry powder, which can be easily removed and the nap of the rug restored by a thorough vacuuming with the Kirby with Rug Nozzle attached.

CLEANING RUG RENOVATOR

It is important for good operation that the Rug Renovator be cleaned after each use.

Remove the hose from the tank. Remove the tank from the neck of the Kirby motor unit, then remove the air filter and slip the Suds-O-Screen off the tank. Rinse the sponge filter and Suds-O-Screen under running water. Remove the tray and nozzle assembly from the motor unit. Release the belt from the Belt Lifter and remove the Renovator Nozzle from the tray. Rinse the tray under a water faucet to remove the dirty suds and lint, being careful not to saturate the brush. Open the hinged shelf and remove the dirt and lint. Shake any excessive water from the brush before re-using or storing the unit.

When storing the Rug Renovator, be sure the belt is not left up on the Belt Lifter Hook. Leaving the belt on the Belt Lifter Hook will cause the belt to stretch and result in slippage.

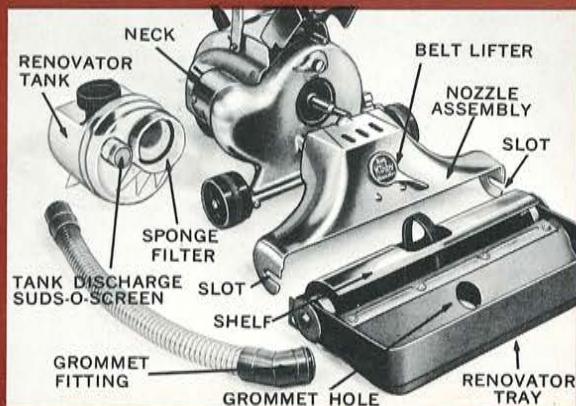

how to use the **BASIC** attachments

The Kirby hose furnished with your standard set of attachments is designed for direct connection to either the "intake" or "blower" side of the Kirby motor unit, by means of the universal coupler attached to the hose.

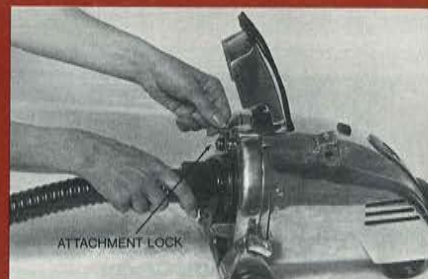

ATTACHING HOSE TO "INTAKE" Set Toe-Touch Nozzle Adjustment at No. 8 position. Hook the attaching slots of the Hose Coupler over the attaching bar at the front of the motor unit. Swing the Hose Coupler back against the motor unit and lock in place with the attachment Lock Lever. Be sure Kirby motor and fan have stopped before changing units.

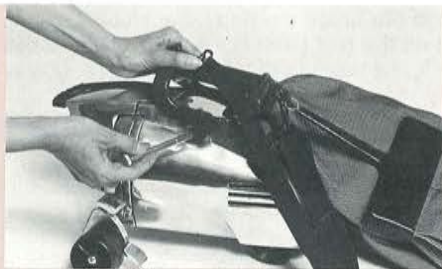

THE PORTABLE HANDLE AND SHOULDER STRAP

Remove Handle Pin and Long Handle. Slide legs of portable handle into place on top of the motor unit as illustrated. Replace Handle Pin. The Shoulder Strap is hooked to the loops provided at top and rear of handle.



ATTACHING HOSE TO "BLOWER OUTLET"

Place Hose Coupler over the neck or blower end of the motor unit and push it into place with a clockwise twist. It will lock into position. When using the Kirby in this fashion, it is necessary to attach the Crystalator to the front (intake) of the Kirby motor unit to depress the Speed Control Switch (Instructions on page 24.) To assure maximum air flow, the Air Vent Slide Cover, on top of the barrel of the Crystalator, should be in the "OPEN" position.



BAG ATTACHMENT FOR PORTABLE UNITS

Sani Em-Tor and bag are attached as explained on page 17. Bag is then folded under and the bag top wire loop is attached to the hook at the back of the Portable Handle.



how to use the SPRAY-GUN/SUDS-O-GUN

THE SPRAY GUN

Assemble the Floor Portable or Shoulder Portable Unit as instructed on pages 22 and 23, except that the Flexible Hose is connected to the blower outlet or neck of the motor unit in place of the Sani Em-Tor. See page 20 regarding attaching hose to "blower outlet." Note when Kirby is used as a "blower," it is necessary to attach the Crystalator to the front of the Kirby motor. The Spray Gun is attached to the hose with a firm twist.

When using a paint intended for use with a brush, it must be thinned for spray application. Follow the paint manufacture's instructions for the proper solvents and the amount of solvent to use. Be sure to use adequate ventilation in order to avoid breathing paint vapor or creating a fire hazard. To fill the Spray Gun Jar, unscrew from the unit and fill about three-fourths full. If you have to tip the spray gun during use, it may be necessary to fill the Spray Gun Jar with a lesser amount to avoid spillage. The telescoping supply tube which projects downward into the jar allows you to obtain the proper length of tubing for any level of liquid in the jar. Larger jars may be used when the tubing is extended further.

Turn on motor and adjust to proper spray. Turning the button at the rear of the gun clockwise makes the spray finer. Pull trigger with index finger to spray.

The gun may be quickly cleaned after use by spraying a solvent or paint thinner through the gun using a clean jar. If necessary the entire assembly may be taken apart by removing the valve stem from the valve seat and immersing these parts in solvent. Spray gun parts are not harmed by ordinary solvents or thinners. Caution, of course, should be used when using any flammable solvent or thinner.

THE SUDS-O-GUN

Assemble Spray Gun as explained above, and place Suds-O-Gun cap over the front of Spray Gun—a clockwise twist will do it.

Mix Kirby Instant Suds as directed on bottle, and fill jar about three-fourths full. Adjust gun to a very fine spray. A volume of very dry suds will then be produced. Suds can be spread directly on surface to be cleaned or gathered in a basin. Test the surface you want to clean for water spot resistance before using the suds, by first applying the suds solution to an area which does not show, allowing it to dry and observing the results.

The suds should be worked into the surface with a brush or sponge until they disappear. Allow a few minutes for surface to dry thoroughly and vacuum with appropriate nozzle to remove the dry froth which now contains the grime and dirt.



how to use the **PORTABLE UNITS**

HAND PORTABLE

This is a powerful unit which will do a magnificent job of cleaning your deep cushions and stair treads. It is especially suited for use on your mattress. When using the Hand Portable on tufted furniture or mattresses, disconnect the revolving brush in the Rug Nozzle by turning the Belt Lifter to "BELT IS OFF" position in order to prevent any chance of pulling up a button. When operating Kirby unit, keep Kirby moving. Do not let it remain running in place over one area.

To assemble, attach the following to the motor unit: Rug Nozzle, (see page 16). The Portable Handle (page 20). The Sani Em-Tor (page 17). Hook the bag top loop to the hook at the rear of the Portable Handle and with the Toe Touch Control (page 9) set the nozzle height at the position most suitable.

SHOULDER PORTABLE

This unit is ideal for cleaning large areas where considerable mobility and freedom of hands are advantages. It is also convenient to use with the Handi-Butler and Flexible Shaft. Assemble the following to the motor unit: Sani Em-Tor and Filter Bag (page 17), and the Portable Handle and Shoulder Strap (page 20). When cleaning, attach the hose to the front of the motor unit (page 20). When you use your Kirby Power Tools, attach the Handi-Butler with Flexible Shaft to the front of the motor unit (page 12).



FLOOR PORTABLE OR TANK TYPE CLEANER WITH SURFACE NOZZLE

This is a unit which gives you the light-weight portability of a tank type cleaner for above-the-floor cleaning operations around your home. Used with various combinations of the tools and extension tubes, you can clean those hard-to-reach areas in your home with ease. To assemble, the following should be attached to the motor unit: Sani Em-Tor and Bag, Suction Coupler, Flexible Hose, and appropriate extension tubes and tools. For complete portability, remove the Long Handle and replace it with the Portable Handle.

Extension tubes and tools are connected simply by inserting the tapered end of the hose or tube into the tool with a firm twist. To release simply twist and pull. The four elliptical bleed holes provided in the end of the Extension Tubes and the Angle Piece that attaches to the Surface Nozzle, are patented, exclusive Kirby safety features. They are intended to prevent injury from excessive suction being inadvertently applied to a sensitive area.

THE SURFACE NOZZLE

This nozzle has been designed to facilitate the surface cleaning of carpets and hard surfaced floors under your low furniture, and for dusting of all hard surfaced floors.

For cleaning carpets, flip Brush Adjustment Lever on front of nozzle to left, so word "UP" appears on lever. This raises the brush to the proper height for carpets. For cleaning hard surfaced floors, flip the lever so word "DOWN" appears on the lever, thus adjusting the brush to the proper height for bare floors. The following is a listing of recommended lever settings for the various types of cleaning you may encounter with your Kirby Surface Nozzle.

UP

Bare floors—dust only
Deep pile rugs
Cotton loop rugs

DOWN

Bare floors—imbedded dirt
Bare floors—lint and fuzz
Short pile rugs

To prevent possible scratching of hard surfaced floors, such as varnished floors, the Surface Nozzle should be used with the Floor Duster Pad.

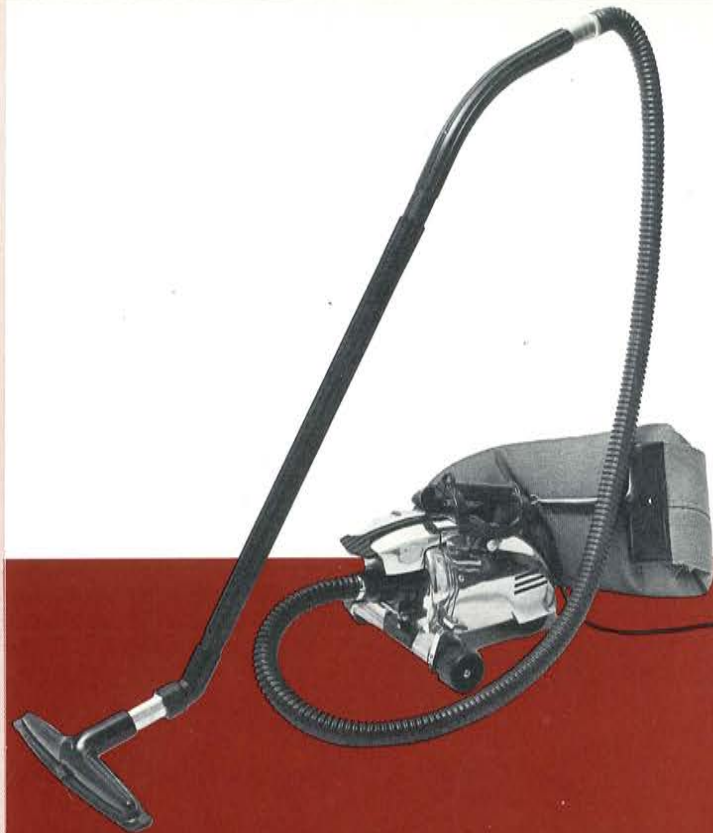

how to use the **CRYSTALATOR**

FILLING THE CRYSTALATOR. Pull the cap off the body of the Crystalator. Pour in Paradichlorobenzine Crystals (moth crystals) until Crystalator is about half full when held in a horizontal position. A finger inserted in the inner cone will close the slot and prevent spillage. Replace cap and turn to desired setting: "GAS" for demisting a closet or other confined area; "MEDIUM CRYSTALS" for furniture, baseboards, carpets, etc.; "FULL CRYSTALS" when it is desirable to deposit large crystals in chests or storage boxes.

NOTE: When using moth crystals, the Air Vent Slide Cover on top of the barrel of the Crystalator should be in the closed position.

ATTACHING THE CRYSTALATOR. Place the attaching slots of the Crystalator over the attaching bar at the front of the motor unit. Swing the Crystalator back against the motor unit and lock in place with the Attachment Lock Lever.

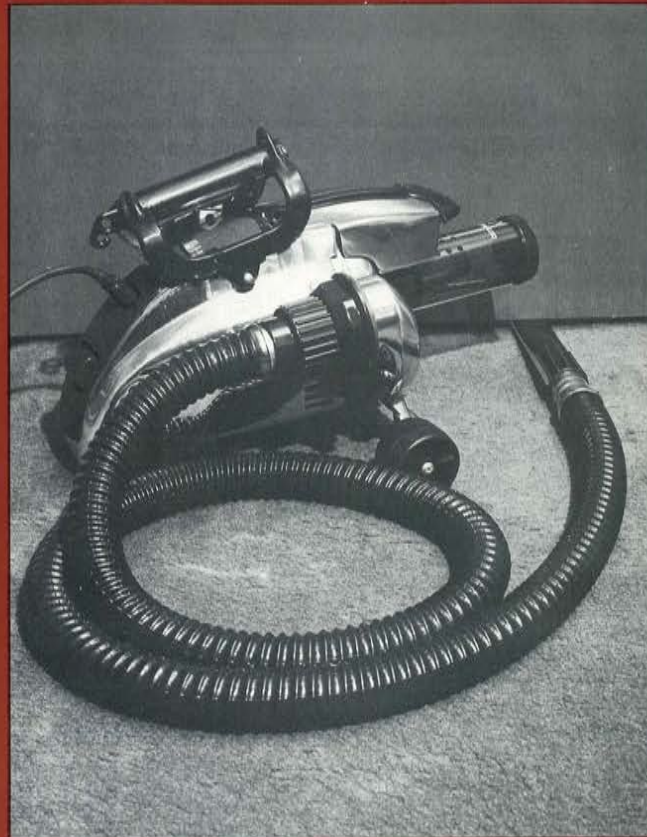

USE WITH HOSE. Assemble the Crystalator Unit as described on the preceding page and also attach the hose and the Crevice Tool to the blower outlet. See illustration at the right. The Crevice Tool Brush may be removed by squeezing the wire together at the point where it enters the tool and pulling straight out.

DE-MOTHING A CLOSET. Place Crystalator with hose and crevice tool (without brush) on floor in front of closed closet door. Position crevice tool so that air flow is directed into closet from under the door. Use a throw rug around crevice tool to seal the remaining opening under door. Turn the Crystalator cap to the "Gas" position, and turn on motor. Allow the motor to run 5 to 15 minutes, depending on the size of the closet.

If crystals cling together, they tend to stop the action of the Crystalator. If this happens, just place your hand over the holes in the top of the Crystalator body for a second while the motor is running. This will loosen the crystals and start them flowing into the fan chamber.

The Crystalator with hose and crevice tool (without brush) attached may also be used to demoth clothes in a garment bag as illustrated in the photo to the right. As Paradichlorobenzene attacks vinyl, the Crystalator should only be used in this manner with garment bags made of polyethylene.

CAUTION:

Follow directions and cautions on label of crystal container. Keep crystals out of reach of children. Crystals may be harmful if taken internally. Do not breathe the concentrated gas from the Crystalator. Do not enter a treated closet until it has been ventilated. Do not remain in a treated room until gas concentration is reduced to safe level. If eye, throat, or skin irritation occurs, do not remain in treated area. Return unused crystals to closed container and seal tight. In the Crystalator, use only 100% pure paradichlorobenzene with U.S.D.A. registration number on the container.

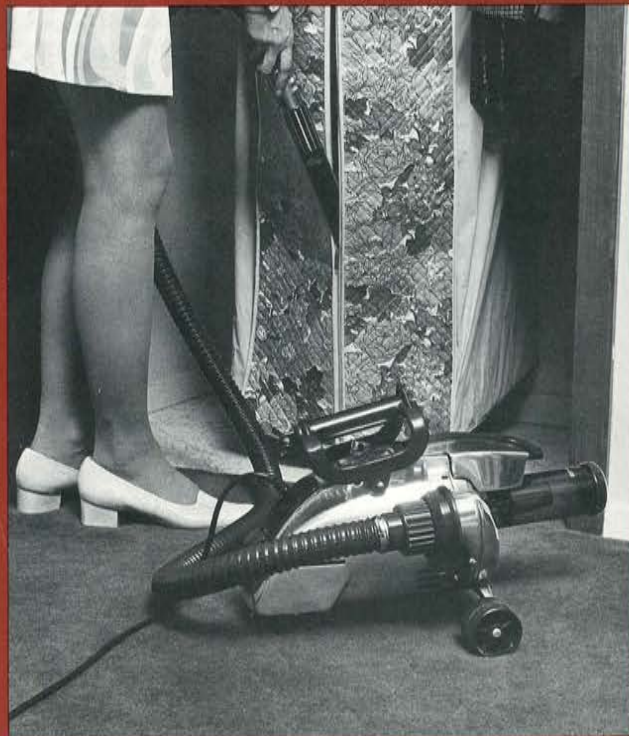

MIRACLE WAXER

HOW TO ASSEMBLE IT

1. Assemble the handle by inserting the tapered end of each of two sections to its mating section, and making a firm twist. A light tap on the floor with the assembled handle will keep the handle assembled while in use. If permanent assembly is desired, give the threaded end of the assembled handle a sharp tap against a carpeted floor.
2. Screw the threaded end of the assembled handle into the Miracle Waxer Body until firmly seated. *Do not overtighten.*
3. Remove the Wax Roller from its storage cylinder and snap it into place in the retaining yoke of the Miracle Waxer Body by first inserting the large fixed end of Wax Roller into the large yoke end then snapping the small push button end of the Wax Roller into the push button side of the retaining yoke.
4. Check to see that the cross feed plug and end plugs are firmly in place.

HOW TO LOAD IT

1. Remove the cover from the tank of the Miracle Waxer and pour in Kirby Creme Wax up to the desired notch in the step gauge inside the tank. Each notch represents approximately 60 square feet of coverage. Always replace the tank cover after filling the tank with wax. *Do not fill tank above the top notch.*

HOW TO USE IT

1. Set the roller of the assembled and loaded Miracle Waxer on the floor to be waxed, and open the valve by rotating the handle counter clockwise about one turn, which will permit the wax in the tank to flow into the supply tube.

When the supply tube is filled as indicated by wax in the transparent end caps, close the valve by turning the handle clockwise, as shown by the arrows on the handle grip.

2. Roll the wax on the surface of the floor as you would use a paint roller. Spread out the wax as thin as possible. The thinnest coating provides the quickest drying time and the brightest shine when polished.

3. When the initial fill in the supply tube is exhausted, replenish the supply tube by opening the valve (turn handle counter clockwise) to release another quantity of Kirby Creme Wax from the tank. When the supply tube is again filled, close the valve by turning the handle clockwise.

AFTER USING THE MIRACLE WAXER

1. Pour any wax remaining in the tank back into the Kirby Creme Wax container before disassembly.

2. Remove the wax roller from the body by depressing the button on the end marked "push". If the Miracle Waxer is used frequently, the roller may be stored in its storage tube with the wax still in it. If the Miracle Waxer is not used frequently, the roller should be rinsed out in warm water, squeezed out and placed in the storage tube. The roller need not be dried before putting it in the storage tube.

3. Unscrew the handle from the Miracle Waxer and wipe wax from valve tip. Remove the tank cover, end plugs and cross feed plug from the Miracle Waxer body. Rinse all parts thoroughly in warm water, dry and put away.

4. Avoid storing the Miracle Waxer in a hot, dry place.

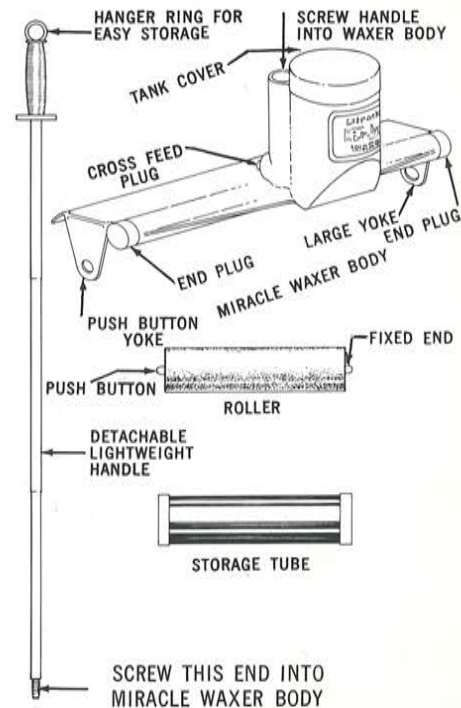

IMPORTANT—Use only Kirby Creme Wax as the rate of flow is carefully controlled to match the Miracle Waxer itself and give just the right application to the floor.

SHAG KING

ATTACHMENT AND REMOVAL

Attachment and removal of the Shag King is easily accomplished by using the thumb tabs on each side of the Shag King frame to spring the frame tabs into or out of the two blind holes in each side of the Kirby Classic Omega Rug Nozzle.

Attachment and removal of the Shag King is made easier when the Kirby Classic Omega Toe Touch Control is in the highest position, and the Shag King has been adjusted to the "OFF" position as described below.

USING THE SHAG KING

The Kirby Shag King can be adjusted to four positions, which in conjunction with the eight positions provided by the Toe Touch Control of the Kirby Classic Omega will provide the correct cleaning and combing height for any shag rug or carpeting.

Adjustment of the Shag King is made by pressing *inwardly* on the stainless steel tabs on each side of the Shag King so that the tabs may be moved to engage one of the four adjustment notches. With the stainless steel tabs in the notch closest to the Rug Nozzle, the tines of the Shag King are raised off the floor. This position should be used when cleaning short pile rugs and carpeting or when attaching or removing the Shag King. The further you move the tabs towards the front of the Shag King, the deeper the raking and combing action.



Kirby INSTANT SUDS

Now you can shampoo carpets, upholstered furniture, and other household articles with volumes of deep cleaning suds. For cleaning carpets and rugs, set up the Kirby for Rug Renovator operation, fill tank with warm water to "fill line" (one quart) and add four ounces of Kirby Instant Suds using the Renovator Tank Cap as a measure. For cleaning upholstered furniture and other household articles, set up the Kirby for spray gun operation and mix six bottle caps full of Kirby Instant Suds with $\frac{3}{4}$ jar full of lukewarm water. Attach the Sud-O-Gun screen to the front of the Spray Gun. Using a fine setting of the adjustment screw, you can make a tremendous volume of suds from a small amount of liquid. Direct the suds into a bowl, or over a small area of the surface to be cleaned, and brush suds into the surface until the suds disappear. After drying, remove the residue (which now contains the dirt) by vacuuming with your Kirby. Kirby Instant Suds come in an unbreakable 12-ounce plastic bottle, and full directions are included on the label. The combination of cleaning power, resoiling resistance, mildew prevention and fabric brightener makes Kirby Instant Suds an outstanding product.

Prior to using on any fabric check for color fastness by applying small amount to material in area where it will not show. Also check to determine effect on materials such as velvet, brocades, etc.

Kirby CREME WAX

Kirby Creme wax is a specially formulated slip resistant creme wax. One hundred percent of the natural wax is number one Carnauba. Its rate of flow is carefully controlled to match the Miracle Waxer itself and give just the right application to the floor.

No other type of wax should be used in your Kirby Miracle Waxer.

Kirby Creme wax can be used on all types of hard surfaced floors, and furniture, or to polish a clean car. It is rebufferable and gives a high gloss when polished with the Kirby Miracle Head.

This wax dries with a dull appearance. Drying time depends on the thickness of the coating and atmospheric conditions. Unlike waxes with hazardous volatiles, additional drying time of the Kirby Creme wax does not affect the final results — you can polish it hours after application.



ODORIFIC

Kirby's all-purpose deodorizer makes the Kirby System an even more complete system of home maintenance.

Odorific neutralizes and eliminates odors. ODORIFIC gives instantaneous, economical and long-lasting results. ODORIFIC is a new concept in deodorizing. It is *not* a masking perfume that simply covers-up unpleasant odors with a more pleasant scent.

One $\frac{1}{4}$ -ounce bottle of Odorific is packed with every Kirby.

One drop of ODORIFIC is enough to neutralize the odors in a 1,000 (10 x 10 x 10) cubic foot area for a 24-hour period.

Odorific neutralizes all odors created by cooking, pets, lavatories, garbage, etc.

Odorific is ideal for use in refrigerators, closets, garbage containers, cellars, shoes, vacuum cleaners, bathrooms, sickrooms, nurseries, living rooms, kitchens, and wherever you want to eliminate unpleasant odors.

Odorific should be used sparingly because every drop is effective.

Odorific will act fastest when used in a manner that will speed its evaporation, such as on a warm surface, or in an air current from a window, door, or air conditioning unit.

Odorific is non-toxic and safe to use. In event of contact with eyes, flush eyes with water. It may discolor certain plastics, rubber or paint surfaces.

Odorific comes in an easy to use "tap-a-drop" bottle.

Here's how to use Odorific

Refrigerators. Dilute 2 drops of ODORIFIC in the water used in washing out the refrigerator.

Closets. To get and keep closets smelling fresh, use one drop of ODORIFIC every two to three days for two weeks. Reduce to one drop per week thereafter.

Apply ODORIFIC directly to closet carpet or floor, or apply to cotton ball and place on shelf.

Pets. One drop of ODORIFIC daily near the spot where pet odors collect will easily overcome them.

Two drops of ODORIFIC in the pet's bath water will give your pet a fresh clean smell.

If ODORIFIC gets in contact with the eyes, flush with water.

KIRBY Vacuum. One drop of ODORIFIC in the Sani-Pocket eliminates any odors from the filter bag.

Apply directly to inside of Sani-Pocket, or apply to cotton ball and place in Sani-Pocket, or turn on Kirby and pick up cotton ball on which you have applied ODORIFIC.

Garbage Containers. One drop of ODORIFIC a day on inside cover of garbage container will eliminate garbage odors.

When washing out the inside of container, use two drops of ODORIFIC in rinse water.

Kitchens. Tap out a drop of ODORIFIC on warm surface of stove away from burners to effectively eliminate all cooking odors such as fish, cabbage, etc.

Air Conditioner and Heater Units. Place a drop of ODORIFIC on the grill of any air conditioning or heater unit sending air into a room. Place two or three drops on a cotton ball or swab and attach it to the grill of the unit.

Repeat as conditions warrant. This method is effective for deodorizing large rooms, halls, etc.

Bathrooms. For average size bathrooms, use one drop daily on part of porcelain surface.

Stale Air, Beer, Smoke. For heavy odors resulting from stale air, beer, and smoke accumulation, use one or two drops of ODORIFIC, depending on size of room.

Paint. Place two drops of ODORIFIC in each door opening or a total of four to six drops in the room to be painted. Apply ODORIFIC ten to fifteen minutes before painting for best results.

Do not apply to surface to be painted.

Nursery. Place one drop of ODORIFIC in waste basket or on the floor to eliminate nursery odors caused by soiled diapers, etc. If soiled diapers have accumulated, place one or two drops of ODORIFIC on inside cover of diaper container.

Sickroom. One to two drops of ODORIFIC on a blotter, cotton ball or cotton swab will neutralize sickroom odors.

One drop on towel covering the bed pan will prove very effective.

Cellars. For musty cellars with odors of pets, oil, coal, storage, washing, etc., use one drop of ODORIFIC in each corner of cellar for several days.

Personal Use. ODORIFIC is a true all-purpose deodorizer which is equally effective for personal use. It does not mask odors with an overpowering perfume, nor does it in any way prevent the normal body functions of perspiration.

One or two drops of ODORIFIC in a wash basin of water, and applied to under-arms with cotton pads or hands will neutralize odors and remain effective for 24 to 28 hours.

One drop of ODORIFIC in each shoe, or one to two drops in foot bath water will eliminate foot odors for several days.



Kirby SCUTTLE

The superior all-purpose cleaner is economical, pleasant smelling, fast working, easy cleaning, and safe using.

Just spray on SCUTTLE and wipe dirt and grease off windows, tile, appliances, walls, painted woodwork, chrome, stainless steel, mirrors, vinyl, plastic, porcelain, aluminum—and a wide variety of other materials and items.

For best results on glass and shiny surfaces, wipe dry with a cloth or paper towel. Clean from bottom to top on large areas to avoid streaking.

For tough jobs, stubborn areas, heavy built-up soil, textured washable surfaces, heel marks, built-up floor wax, crayons and greasy marks, grills and range hoods, vinyl covered furniture, painted concrete block walls, vinyl auto tops, etc., spray on

SCUTTLE, let it stand for a few seconds, then lightly scrub with a pre-wet soft bristle brush. Wipe with a damp cloth and follow-up with a dry cloth.

Use SCUTTLE to boost the cleaning power of Kirby Instant Suds when renovating heavily soiled rugs or carpeting. Add one tank cap measure of Kirby SCUTTLE to suds solution in Rug Renovator Tank, or spray directly on spot just before shampooing.

Scuttle is truly the superior all-purpose cleaner.

Scuttle is non-toxic and safe to use. SCUTTLE is gentle to hands, too. If sprayed in eyes, flush with water.

Scuttle is available in 12 ounce plastic bottles with finger-type sprayer and in 32 ounce refill bottles without the sprayer.



HELPFUL HOME SERVICE HINTS

If Kirby will not pick up lint or ravelings on carpet, check to see if:

1. Belt Lifter is in "OFF" position (Page 8).
2. Belt is broken or worn out (Page 33).
3. Brush needs adjustment (Page 32).
4. Toe Touch Nozzle Adjustment is improperly adjusted (Page 9).
5. Filter Bag needs emptying (Page 11).
6. Brush needs cleaning (Page 32).

If motor will not run and light does not light:

1. Check to make sure cord is properly plugged into the Kirby and wall outlet.
2. Make sure there are no breaks in cord. Check by attaching to a floor lamp and flexing back and forth along entire length of cord. Pay particular attention to male and female connectors at ends of cord.
3. Make sure that the Rug Nozzle, Crystalator, Handi-Butler, Miracle Head, Hose or Rug Renovator is properly in place on the front of the motor unit.
4. Check your wall switch to make sure power is on at wall socket.

If Rug Nozzle is loose even after proper attachment:

1. Attachment lock not turned tight enough.

If Sani Em-Tor is loose:

1. Check to be sure it is locked in position by turning clockwise as far as possible, (see Page 17).
2. Check to see if rubber gasket inside collar of Sani Em-Tor is properly in place.

If Miracle Head brush will not revolve:

1. Make sure Belt Lifter is in "ON" position.
2. Check condition of belt—replace if necessary. (See Page 33).
3. Make sure belt is not wet with wax.

If Handi-Butler work wheels will not revolve or stop under light pressure:

1. Make sure Belt Lifter is in "ON" position.
2. Check belt and replace if broken, worn, or stretched. (See Page 33).

If dirt will not fall out of bag and Sani Em-Tor:

1. Too much dirt has been allowed to accumulate and it is jamming the large opening of the Sani Em-Tor where the bag is attached. Use Sani-Scraper in Sani-Pocket to clean bag and force dirt into Sani Em-Tor. (See Page 11).

If Kirby is hard to push when Rug Nozzle is attached:

1. Toe Touch Nozzle Attachment set too low. Raise one or two notches. (Page 9).



BRUSH ADJUSTMENT AND CLEANING

Through usage, the revolving brush in the Rug Nozzle will gradually wear down. When it fails to protrude approximately 1/16 inch beyond the stainless steel rug guard—check by laying a flat piece of stiff cardboard across a portion of the rug guard—turn the Brush Roll Adjustment Screws at each end of the Brush Roll clockwise with a screwdriver until the proper amount of bristle protrudes. Be sure to turn each screw an equal amount so the same amount of bristle protrudes on each end of the Brush Roll.

TO REMOVE BRUSH ROLL FROM RUG NOZZLE

1. Remove nozzle from motor unit.
2. Turn Belt Lifter to "ON" position to release belt from Belt Lifter Hook.
3. Remove Rug Guard from nozzle.
4. Spread Support Brackets by bending slightly away from Brush Roll. The brush may then be removed for cleaning.
5. Use scissors to cut string, thread, or hair which may be wrapped around the Brush Roll. An old comb is also useful in removing foreign matter embedded in brush tufts.

REPLACEMENT OF BRUSH ROLL

1. Place ends of Brush Roll into Rug Guard Support Brackets—one end is wider than the other so it can be replaced only the correct way.
2. Bend the Support Brackets back into place.
3. Make sure belt is positioned in center of Brush Roll.
4. Press Brush Roll Assembly into nozzle. Make sure the word "FRONT" is toward front of nozzle and Rug Guard Rim is seated firmly all around the edge of the nozzle.



BELT REPLACEMENT

RUG RENOVATOR

1. Remove the Renovator Nozzle Assembly and the Tray Assembly from the motor unit.
2. Release the belt from the Belt Lifter.
3. Remove the Renovator Tray from the nozzle assembly.
4. Remove the screw and plastic bumper from both sides of the Tray using a Phillips screwdriver.
5. Remove belt by sliding it out over the end of the Brush Roll.
6. Install new belt by reversing above steps.

RUG NOZZLE

If the Rug Nozzle fails to remove lint from the surface of the carpet, the cause of the difficulty may be a weak or broken belt.

1. Remove the Rug Nozzle from the motor unit.
2. Remove the Brush Roll from the Rug Guard as explained on page 32.
3. Remove belt by sliding it out over the end of the Brush Roll.
4. Install new belt by reversing above steps.

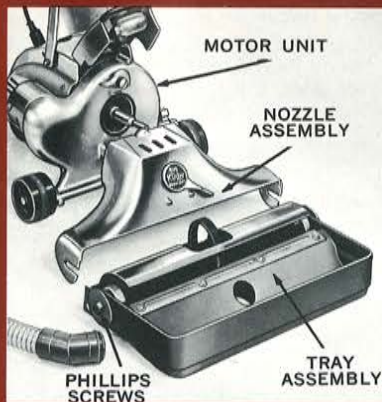

HANDI-BUTLER

1. Remove Handi-Butler from motor unit.
2. Remove work wheels
3. Turn Belt Lifter to "ON" position.
4. With screwdriver slide belt off Belt Lifter finger.
5. Remove belt by sliding it out over drive shaft to which work wheels are attached.
6. Install new belt by reversing above steps.

MIRACLE HEAD

1. Remove the Miracle Head from the motor unit.
2. Turn the Belt Lifter to "ON" position.
3. Loosen screw at one end of nozzle about a half turn with a Phillips screwdriver.
4. Remove the screw and rubber bumper from the other end.
5. Swing the Brush Roll out slightly being careful not to bend axle or remaining screw.
6. Remove belt by sliding it out over the open end of the Brush Roll.
7. Install new belt by reversing above steps.



BULBS / CORD / FILTER BAG / LUBRICATION

Your Kirby motor has been properly lubricated at the Factory and should not need additional lubrication for several years. If additional lubrication is required, safety regulations require that any repairs calling for the removal of the motor shell, must be done only by qualified Kirby authorized service personnel.



CORD SERVICE

The Kirby cord can be easily removed from the Kirby for use as an emergency extension cord. With reasonable care it will last for years.

The Kirby cord should not be used if power is greater than 125 volts, 875 watts.



FILTER BAG MAINTENANCE

Keep the plastic Bag Guard in place around the point where the bag is fastened to the Sani Em-Tor. This will minimize wear, and under average use, your bag will last for many years. The only time it will need replacement will be at times of general overhaul. The bag is fastened to the Sani Em-Tor with a strong spring, and reasonable strength and skill is required for its replacement.



BULB REPLACEMENT

Access to the headlight is gained by removing the two screws which hold the lens cover in place. The headlight bulb is held in the socket with a conventional bayonet base fitting. To assure continuing safety benefits of Kirby's double insulated motor, it is necessary that bulb replacement be done only by qualified Kirby authorized service personnel.



IMPORTANT

THE KIRBY GENERAL SERVICE INSURANCE, COVERAGE OF LOSS BY FIRE, AND LIMITED WARRANTY DESCRIBED BELOW ARE EACH NULL AND VOID IF (1) THE KIRBY WAS NOT PURCHASED FROM AN INDEPENDENT AUTHORIZED KIRBY DISTRIBUTOR, AREA DISTRIBUTOR, OR DEALER WHO SIGNED PAGE 36 OF THIS WARRANTY AND INSTRUCTION BOOK AND FILLED IN THE DATE AND SERIAL NUMBER OR IF (2) THE NAME PLATE OR SERIAL NUMBER 1, OF THE KIRBY HAS BEEN DEFACED, REMOVED, OR CHANGED (OTHER THAN BY FIRE OR OTHER CASUALTY OR ACCIDENT, OR IN CONNECTION WITH FACTORY AUTHORIZED REBUILD).

PROTECT YOUR RIGHTS: MAKE SURE YOU ARE (1) PURCHASING FROM AN INDEPENDENT AUTHORIZED KIRBY DISTRIBUTOR, AREA DISTRIBUTOR, OR DEALER AND (2) PAGE 36 IS FILLED IN AND SIGNED, AND (3) THE ORIGINAL NAME PLATE AND SERIAL NUMBER IS INTACT.

GENERAL SERVICE INSURANCE

Subject to the conditions and exceptions stated below, The Kirby Company Division of The Scott & Fetzer Company ("Company") hereby agrees with the original purchaser of a new Kirby to entirely rebuild and re-condition the Kirby, as often as may be required, provided it is still owned by and in the possession of the original purchaser, and provided it is returned, transportation prepaid, to the Company's factory in Cleveland, Ohio 44102, subject to the following:

1. The Company, in rebuilding and re-conditioning the machine for the original purchaser, will make every effort to keep the cost to such purchaser for this service as low as possible and the Company will, in no case charge such purchaser more than \$49.50 for any one rebuild.
2. The Company's maximum price of \$49.50 shall include all labor and cost of all parts (except for broken or missing parts) necessary to put the Kirby in A-1 condition.
3. All transportation charges, and replacement costs of broken parts or missing parts, shall be paid for by the purchaser.
4. THE GENERAL SERVICE INSURANCE IS NULL AND VOID IF (1) THE KIRBY WAS NOT PURCHASED FROM AN INDEPENDENT AUTHORIZED KIRBY DISTRIBUTOR, AREA DISTRIBUTOR OR DEALER WHO SIGNED PAGE 36 OF THIS WARRANTY AND INSTRUCTION BOOK AND FILLED IN THE DATE AND SERIAL NUMBER OR (2) THE NAME PLATE OR SERIAL NUMBER OF THE KIRBY HAS BEEN DEFACED, REMOVED OR CHANGED (OTHER THAN BY FIRE OR OTHER CASUALTY OR ACCIDENT, OR IN CONNECTION WITH FACTORY AUTHORIZED REBUILD).

COVERAGE OF LOSS BY FIRE

Subject to the conditions and exceptions stated below, The Kirby Company Division of The Scott & Fetzer Company ("Company") agrees

with the original purchaser of a new Kirby that in the event that the Kirby, while owned by and in the possession of the original purchaser, should be damaged or destroyed by fire, on the premises of such purchaser, the Company will repair or rebuild the Kirby for such purchaser and return it in A-1 condition, provided that such purchaser sends \$49.50 and the fire damaged remains, transportation prepaid to the Company's factory in Cleveland, Ohio 44102 within ninety (90) days after the date of the damaging fire. If the cost of labor and parts necessary to repair or rebuild the Kirby should be less than \$49.50, the difference between such cost and \$49.50 shall be returned to such purchaser by the Company.

If, while owned by and in the possession of the original purchaser, the Kirby Miracle Head, Handi Butler, Flexible Shaft, Miracle Waxer, Rug Renovator or cleaning tools are damaged or destroyed by fire, on the premises of such purchaser, the Company will replace any such item, provided that such purchaser sends the appropriate amount indicated below and the fire damaged remains, transportation prepaid, to the Company's factory in Cleveland, Ohio 44102 within ninety (90) days after the date of the damaging fire: the Kirby Miracle Head, \$8.00; the Kirby Handi Butler and Flexible Shaft, \$16.00; the Kirby Miracle Waxer, \$10.00; the Kirby Rug Renovator, \$16.00; and cleaning tools, \$10.00.

This coverage is based upon the condition that such purchaser has met all the requirements of the purchaser's original purchase agreement, and it is specifically understood that repair, rebuild or replacement of any item under this coverage will in no way nullify or modify the terms of that purchase agreement. If the fire-damaged item has not been fully paid for under an installment purchase plan, a statement from the lender certifying that installment payments are current will be required.

In the event that the Kirby Miracle Head, Handi Butler, Flexible Shaft, Miracle Waxer, Rug Renovator, or cleaning tools, while owned by and

in the possession of the original purchaser, shall be completely and wholly destroyed by fire, on the premises of such purchaser, so that no damaged remains can be returned, an affidavit, sworn to by the original purchaser before a notary public, affirming such complete destruction, will be accepted within ninety (90) days after the date of the damaging fire in lieu of damaged remains, and the destroyed item will be replaced under the terms set forth above.

All transportation charges shall be paid by the purchaser.

THE COVERAGE OF LOSS BY FIRE IS NULL AND VOID IF (1) THE KIRBY WAS NOT PURCHASED FROM AN INDEPENDENT AUTHORIZED KIRBY DISTRIBUTOR, AREA DISTRIBUTOR OR DEALER WHO SIGNED PAGE 36 OF THIS WARRANTY AND INSTRUCTION BOOK AND FILLED IN THE DATE AND SERIAL NUMBER OR (2) THE NAME PLATE OR SERIAL NUMBER OF THE KIRBY HAS BEEN DEFACTED, REMOVED OR CHANGED (OTHER THAN BY FIRE OR OTHER CASUALTY OR ACCIDENT, OR IN CONNECTION WITH FACTORY AUTHORIZED REBUILD).

LIMITED WARRANTY

Subject to the conditions and exceptions stated below, The Kirby Company Division of The Scott & Fetzer Company ("Company") warrants each Kirby product to be free from defects in material and workmanship under normal use and service. At any time within one year from the date of purchase by the original purchaser, the Company will furnish for the Kirby product, a replacement part for any part returned to and found by the Company to be defective. Such replacement part will be furnished without cost to the original purchaser (except transportation charges) through an authorized Kirby service center or f.o.b. Company's factory at the Company's election. This Warranty does not apply to belts, light bulbs, charges for labor or service calls, damage caused by accident, misuse, negligence, abuse, or to any Kirby product which has been repaired so as in the judgment of the Company to affect its stability or reliability, or in which parts not approved by the Company shall have been used. In approving the Kirby for double insulation, Underwriters' Laboratories requires that only identical parts should be used in servicing the sealed motor unit.

The foregoing provisions state the exclusive remedy for any breach of warranty or any other claim in respect of any Kirby product. THERE IS NO OTHER EXPRESS WARRANTY, IMPLIED WARRANTIES, INCLUDING THOSE OF MERCHANTABILITY AND FITNESS FOR A PARTICULAR PURPOSE, ARE LIMITED TO ONE YEAR FROM THE DATE OF PURCHASE BY ORIGINAL PURCHASER; AND TO THE EXTENT PERMITTED BY LAW,

ANY AND ALL IMPLIED WARRANTIES ARE EXCLUDED. THIS IS THE EXCLUSIVE REMEDY, AND ANY LIABILITY FOR CONSEQUENTIAL DAMAGES IS EXCLUDED TO THE EXTENT EXCLUSION IS PERMITTED BY LAW. The Company neither assumes, nor authorizes any other person to assume for it, any additional liability in connection with the sale of its products.

THE LIMITED WARRANTY IS NULL AND VOID IF (1) THE KIRBY WAS NOT PURCHASED FROM AN INDEPENDENT AUTHORIZED KIRBY DISTRIBUTOR, AREA DISTRIBUTOR OR DEALER WHO SIGNED PAGE 36 OF THIS WARRANTY AND INSTRUCTION BOOK AND FILLED IN THE DATE AND SERIAL NUMBER OR (2) THE NAME PLATE OR SERIAL NUMBER OF THE KIRBY HAS BEEN DEFACTED, REMOVED OR CHANGED (OTHER THAN BY FIRE OR OTHER CASUALTY OR ACCIDENT).

THE KIRBY COMPANY
DIVISION OF THE SCOTT & FETZER COMPANY
CLEVELAND, OHIO

Manufacturers of the Kirby Classic Omega
ADRIAN E. BUDLONG Jr.
President and Chief Executive Officer

Service calls, including the one-year warranty period, will be at the expense of the owner.

PLEASE COMPLETE THE FOLLOWING

The above Warranty covers the Kirby Classic Omega:

Serial No. _____

Date of Delivery _____

Authorized Dealer Signature

INDEX

- | | | | | | | | |
|------------------|-----------------|----------------------------------|----------------|------------------------|--------------|--------------------------------|-----------|
| Attachments | 5, 6, 7, 20, 22 | Floor Duster Pad | 4, 18 | Miracle Waxer | 2, 26 | Shoulder Portable | 4, 22 |
| Attachment Lock | 6, 12, 16 | Floor Polisher | 3, 18 | Motor Switch | 10 | Shoulder Strap | 20 |
| Bag | 11, 17, 20, 34 | Floor Portable | 3, 23 | Motor Unit | 6, 7 | Speed Selector | 5 |
| Bag Guard | 34 | General Service Insurance | 35 | Odorific | 29 | Spray Gun | 2, 21 |
| Belt Lifter | 8, 12 | Grinding Wheel | 13, 15 | Parts | 6, 7, 13, 15 | Suction Relief Vent | 6, 17 |
| Belt Replacement | 33 | Hand Portable | 3, 22 | Polishing Compounds | 15 | Suds-O-Gun | 2, 21 |
| Blower Coupler | 20 | Handi-Butler | 2, 12, 13, 15 | Portable Handle | 20 | Surface Nozzle | 23 |
| Brush Adjustment | 32 | Handi-Sharpener | 15 | Portable Units | 22, 23 | Swedish Massage Unit | 14 |
| Brush Cleaning | 32 | Handle Lock | 10 | Power Tool | 2, 13, 15 | Switch, Motor | 6, 10 |
| Brush Roll | 32, 33 | Handle, Long | 16 | Rebuild Service | 35 | Switch, Safety | 5 |
| Buffing Wheels | 15 | Handle, Pin | 16 | Rug | 3, 16, 17 | Swivel Nozzle | 6, 7 |
| Bulb Replacement | 34 | Handle, Portable | 20 | Rug Guard | 32 | Swiveled Cord Hook | 5, 17 |
| Cord | 17, 34 | Headlight Replacement | 34 | Rug Nozzle Adjustment | 9 | Tank-Type Unit | 2, 4, 23 |
| Creme Wax | 28 | Hose | 20 | Rug Nozzle Attachment | 16, 17 | Tilt Latch | 10 |
| Crystalator | 2, 24, 25 | Hose Locking Nut | 20 | Rug Renovator | 3, 19 | Toe Touch Nozzle
Adjustment | 5, 9 |
| De-Mothing Unit | 2, 24, 25 | Instant Suds | 28 | Sanding Disks | 13, 15 | Tool Cabinet | 5 |
| Dirt Trap | 5, 11, 17 | Long Handle | 16 | Sani Em-Tor | 5, 11, 17 | Upright Cleaner | 3, 16, 17 |
| Emptying the Bag | 11 | Lubrication | 34 | Sani-Pocket | 5, 11 | Wands | 23 |
| Extension Tubes | 23 | Maintenance | 31, 32, 33, 34 | Scuttle | 30 | Warranty | 36 |
| Flexible Hose | 20 | Mattress Cleaner | 3, 22 | Service Hints | 31 | Wheel Cups | 12, 15 |
| Flexible Shaft | 13, 15 | Miracle Head | 3, 18, 33 | Shag King | 3, 27 | Wire Brush Wheel | 15 |



Home of the Kirby is a modern plant in Cleveland Ohio which is devoted exclusively to the design, manufacture and testing of the Kirby.

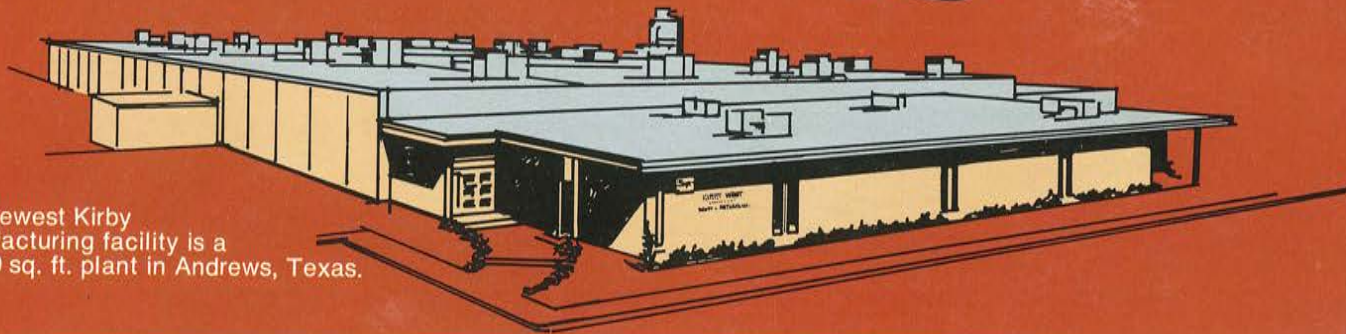

The newest Kirby manufacturing facility is a 96,000 sq. ft. plant in Andrews, Texas.

DIVISION OF



THE KIRBY COMPANY

1920 W. 114 Street • Cleveland, Ohio 44102

IN TEXAS: Kirby West • P.O. Box 670 • Andrews, Texas 79714

IN CANADA: Kirby of Canada • 1009 Burns St. East • Whitby, Ontario L1N6A6

the new
standard of
excellence

Kirby[®]
Classic Ω [®]
Omega[™]

the ultimate
in home
maintenance
equipment

• WARRANTY AND INSTRUCTION BOOK



WARNING:
ELECTRIC SHOCK COULD
OCCUR IF USED OUTDOORS
OR ON WET SURFACES

NOTICE:

The information and specifications included in this Warranty and Instruction Book were in effect at the time of approval for printing. The Kirby Company reserves the right, however, to discontinue or change specifications or designs at any time without notice and without incurring any obligations whatsoever.

this book

is dedicated to you, the owners of the new standard of excellence in home maintenance equipment. It is designed to promote your complete enjoyment of the Kirby Classic Ω . Keep this booklet where it will be handy. Read and review it often, for by knowing your Kirby completely, you will realize full value from your purchase and appreciate the Kirby as a truly marvelous and dependable household friend.

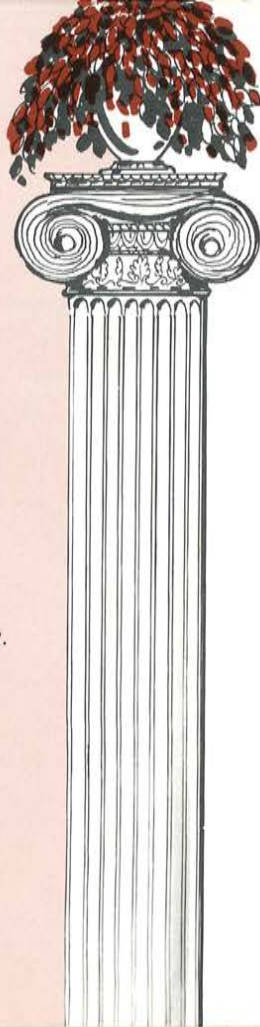

contents

YOUR KIRBY®
 What it does for you Pages 2 to 5
 Its parts Pages 6, 7

HOW TO USE YOUR KIRBY
 Belt Lifter Pages 8, 12
 Toe-Touch Control Page 9
 Motor Switch & Handle Lock Page 10
 Sani Em-Tor™ Pages 11, 17
 Swedish Massage Unit Page 14
 Handi-Butler® Pages 13, 15
 Handi-Sharpener™ Page 15
 Upright Cleaner Page 16
 Suction Relief Vent Page 17
 Duster-Buffer™ Page 18
 Miracle Head™ Page 18
 Rug Renovator™ Page 19
 Basic Attachments Page 20
 Spray Gun, Suds-O-Gun® Page 21
 Portable Units Pages 22, 23
 Surface Nozzle Page 23
 Crystalator™ Pages 24, 25
 Miracle Waxer™ Page 26
 Shag King® Page 27
 Instant Suds & Creme Wax Page 28
 Odorific® Pages 28, 29
 Scuttle® Page 30

HOW TO MAINTAIN & SERVICE YOUR KIRBY Pages 31, 34

KIRBY GENERAL COVERAGE WARRANTY Pages 35, 36

INDEX Page 37

The Kirby Classic Omega, Model ICB is listed and approved by Underwriters Laboratories Inc. as a Double Insulated product for use on 120 volts 50-60 Hz.