

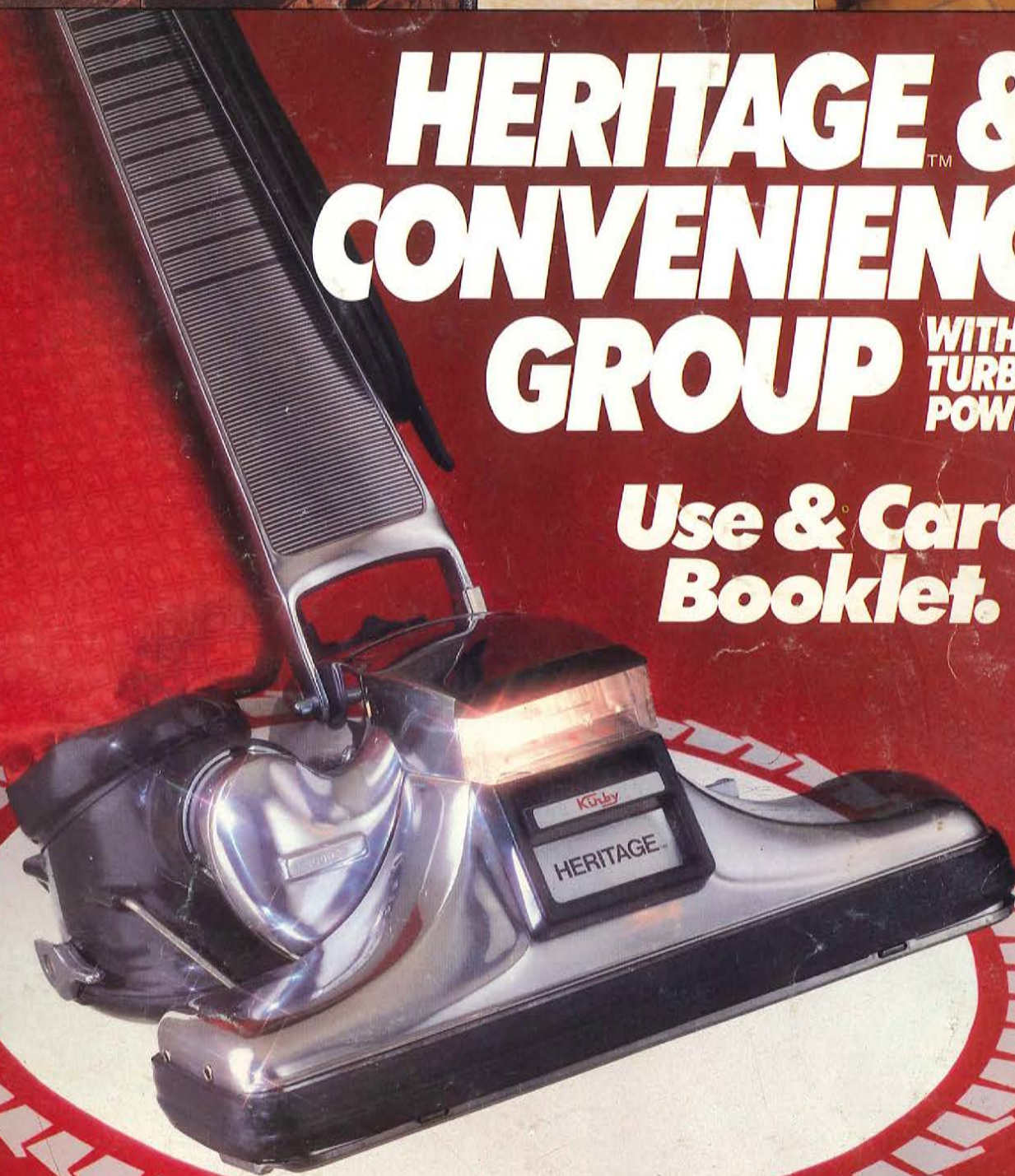

HERITAGE™ & CONVENIENCE GROUP WITH TURBO POWER

**Use & Care
Booklet.**



**SAVE THESE
INSTRUCTIONS.**

Important: Read all instructions,
warnings and safeguards before using.

Kirby®



Congratulations

on becoming a Kirby owner.

With proper care your Kirby Cleaning System will give you a lifetime of service. Because it was designed and built using reliable, high-quality materials.

The Kirby cleaning system gets the cleaning job done faster and easier, leaving more time for yourself or your family.

In the event you require service or information about Kirby attachments and accessories, talk to your authorized independent Kirby distributor or dealer. There's one near you. Check your telephone Yellow Pages.

To fully appreciate the capabilities of the Kirby, please read this **Use and Care Booklet** thoroughly. The information and specifications included here were in effect at the time of printing. The Kirby Company reserves the right, however, to discontinue or change specifications or designs at any time without notice and without incurring any liability whatsoever.

NOTE: Pull this cover out and use detailed drawing of Kirby Heritage™ while following the step-by-step instructions in this booklet.

KIRBY HERITAGE™

Parts List & Controls.

- 1—Optional Reuseable Bag System
- 2—Disposable Paper Bag
- 3—Nut
- 4—Clip in Top Slot
- 5—Handle Grip
- 6—Upper Cord Hook
- 7—Spring
- 8—Screw
- 9—Upright Handle
- 10—Power Cord
- 11—Cord Attaching Groove
- 12—Handle Pin
- 13—Power Plant
- 14—Attaching Bar
- 15—Rug Nozzle
- 16—Belt Lifter
- 17—Accessory Lock
- 18—Air Outlet
- 19—Headlight Hood
- 20—Sani Em-Tor
- 21—Bag Guard
- 22—Cloth Filter Bag and Hanger
- 23—Suction Seal Ring Gasket
- 24—Em-Tor Gasket
- 25—Power Shaft
- 26—Speed Selector
- 27—Clip on Top
- 28—Handle Stop Latch
- 29—Disposable Bag System
- 30—Toe-Touch Control
- 31—Foot Switch

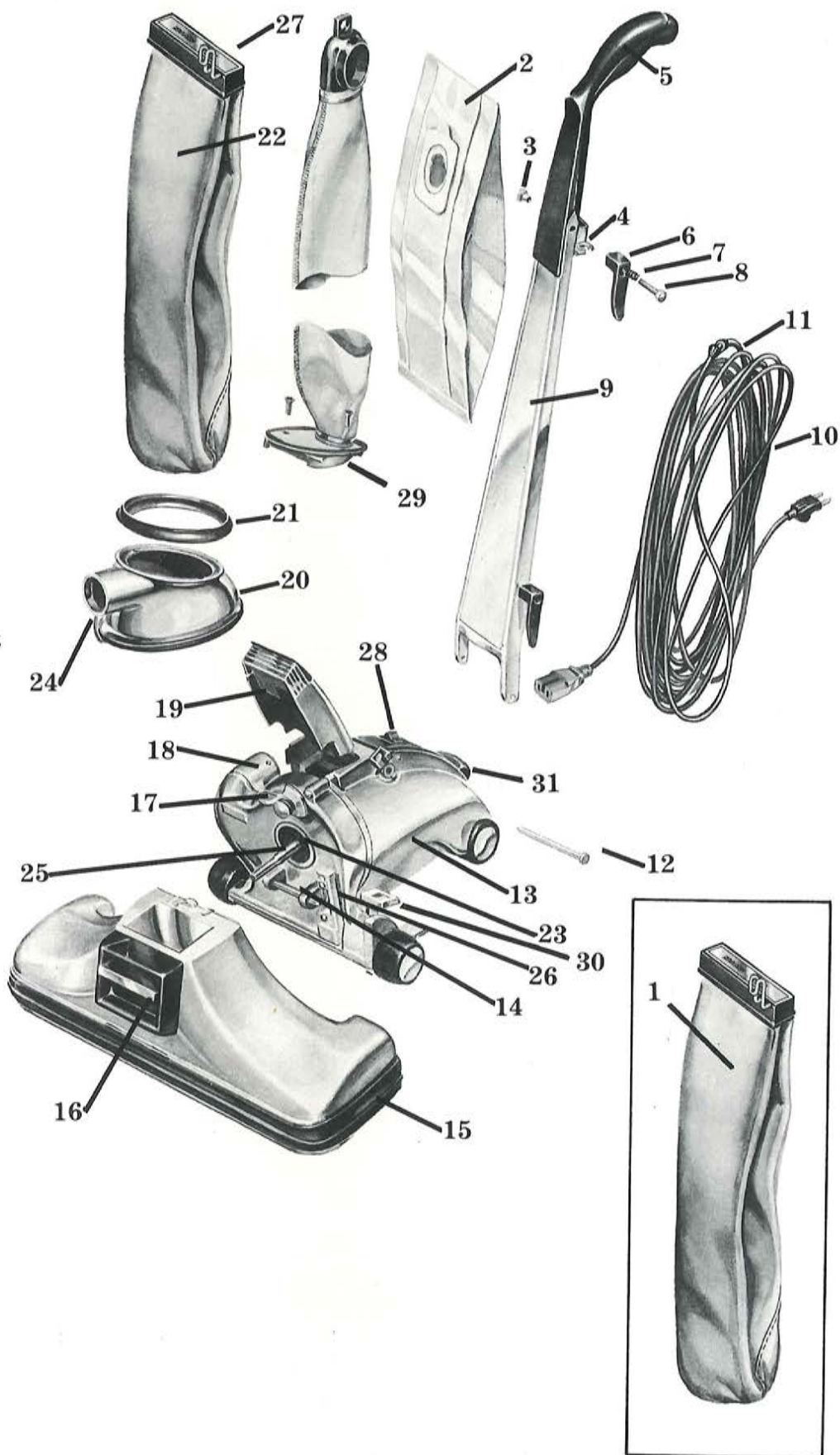

Standard Attachments.

Here are the standard attachments for your Kirby. Each is designed for specific household cleaning jobs. The spare belt can be used with all accessories and attachments which are belt driven, except the Turbo Brush and Handi-Butler. There are detailed instructions for the use of each attachment in later sections of this booklet. Clean each attachment after using and keep brushes free from lint and fibers.



EXTENSION WANDS.

Lightweight, yet strong. Lock securely together. Contain safety air bleeder holes.



CREVICE TOOL.

with removable brush. For crevices in furniture without the brush, and for cleaning radiators and other hard-to-dust places with the brush.



UTILITY BRUSH NOZZLE

For walls, bare floors, ceilings and large, flat hard surfaces.



SURFACE NOZZLE WITH SWIVEL ATTACHMENT.

With brush adjustment lever. For cleaning under low objects, such as couches or television consoles.



TURBO BRUSH.

With mechanical power brushing action to clean difficult places thoroughly.

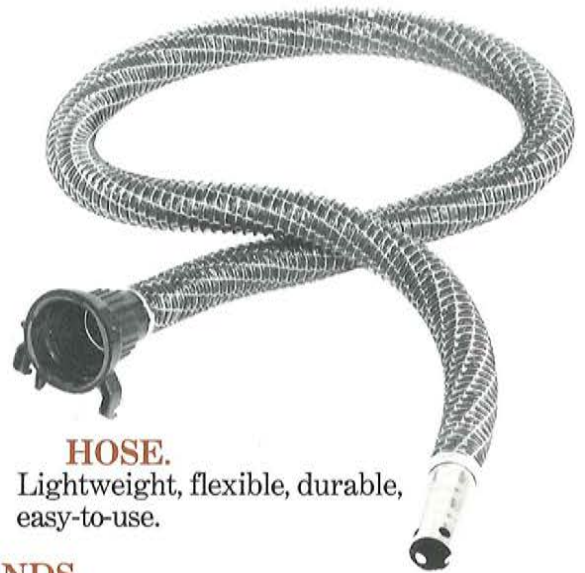

HOSE.

Lightweight, flexible, durable, easy-to-use.



PORTABLE HANDLE WITH SHOULDER STRAP.

Makes your Kirby more versatile and easier to use in a variety of places.



DUSTER BRUSH.

For end tables, shutters, lamp shades, window moldings, cornices, door jams, baseboards, books, picture frames, air conditioning and heating duct openings.

Also included with the basic Kirby cleaner are the following items: ODORIFIC (one bottle). An effective all-purpose deodorizer. ROOM AND CARPET HOME FRESHENER (7 oz. container). Lemon scented to remove pet odors, cooking odors and odors caused by dampness. KIRBY DISPOSABLE BAGS (three). SPARE BELT (one). Can be used with any of the belt-driven accessories, except the Turbo Brush and Handi-Butler.



Table of Contents

Parts List & Controls	3
Standard Attachments	4
Important Safeguards	6

VACUUM CLEANER BAGS.

Disposable Filter Bag System	7
Reuseable Bag System	8

UPRIGHT CLEANER.

Carpet Vacuuming	10
Straight Suction Cleaning	11

MATTRESS CLEANER.

Converting to a Mattress Cleaner	12
--	----

TANK CANISTER CLEANER.

Attaching the hose	14
--------------------------	----

ATTACHMENTS.

Crevice Tool, Duster Brush, Utility Brush Nozzle Shoulder Strap, and Flexible Hose	16
Extension Wands and Surface Nozzle	17

TURBO BRUSH, DEEP CLEANING PORTABLE.

SERVICE TIPS.

Service Tips	18
Belt Replacement	20
Trouble-Shooting	21
Owner's Registration Card	22
Limited Warranty	23
Accessories	24-26

INDEX.

IMPORTANT SAFEGUARDS.

Read all Instructions, Warnings, and Cautions before Using!

The Kirby system is listed by Underwriters Laboratories, Inc. as a Double Insulated Domestic product for use on 120 volts 60 hertz household power.

WARNING

Electric shock could occur if used outdoors or on wet surfaces.

These guidelines, and others found throughout this book, are presented for your protection and convenience. Please read them carefully, since a failure to heed these precautions could result in discomfort or injury. When using electrical appliances, especially when children are present, basic safety precautions should always be followed.

ALWAYS BE SURE MOTOR AND FAN HAVE COME TO COMPLETE STOP, AND UNPLUG CORD FROM WALL SOCKET BEFORE CHANGING ACCESSORY UNITS OR ATTACHMENTS.

DO NOT USE ANY ATTACHMENT NOT RECOMMENDED OR SUPPLIED BY THE KIRBY COMPANY, AND USE ONLY AS DESCRIBED IN THIS MANUAL.

NEVER LEAVE CLEANER UNATTENDED WHEN IT IS RUNNING OR WHEN CORD IS PLUGGED IN.

WHEN CLEANER IS RUNNING, NEVER ALLOW FINGERS, HAIR, FACE OR LOOSE CLOTHING TO COME NEAR INTAKE SUCTION PORTS, NOZZLE, OR REVOLVING BRUSHES.

REPLACE DAMAGED OR WORN PARTS WITH GENUINE KIRBY PARTS IN ORDER TO MAINTAIN SAFETY AND TO PROTECT YOUR WARRANTY.

Never vacuum live fireplace ashes, cigar or cigarette butts.

Never run cleaner over power cord, or place sharp objects on cord. Keep cord away from heated surfaces. Don't close door on cord, or snag it under furniture or doors.

Never let invalids or children use or play with cleaner.

Use extra caution when cleaning on stairs.

Keep cleaner on floor—not on chairs, tables, etc.

When disconnecting power cord, grasp plug—not cord. Do not use cord to pull cleaner around. Do not close a door on it, or snag it under furniture.

Store cleaner, attachments, and accessory units promptly after each use to prevent accidents caused by tripping over power cord or equipment.

Always unplug cleaner immediately after using.

Don't use in an enclosed space where flammable, explosive, aerosol spray products, or toxic materials are stored or used, or where vapors from such materials may be present.

Don't use where oxygen or anesthetics are used.

Don't use cleaner to pick up hard or sharp items, such as coins, pins, nails, etc. They could damage the fan, fan housing or bag.

Never drop or insert any object into any opening of the cleaner.

Don't use cleaner, attachments, or accessory units if in poor condition. Have qualified service person inspect, replace, or repair whenever necessary.

Don't plug cleaner into a table lamp or light fixture.

Don't move tables, lamps, etc., while holding onto cleaner.

Check seals and gaskets regularly. Worn, damaged, loose or missing gaskets or seals can be a safety hazard.

Keep hose and attachments suction openings away from eyes, ears, mouth, and other parts of body.

WARNING

To avoid electric shock:
Never vacuum liquids.
Never vacuum floors, rugs, or carpeting that are wet.
Do not store outdoors.
Replace worn or frayed power cord immediately.

Do not place or immerse cleaner in water or any other liquids.

Do not reach for cleaner that has fallen into water. Unplug cleaner immediately from the wall socket.

Never handle cord or plug with wet hands.

WARNING

Before servicing always unplug power cord from wall outlet and be sure the motor and fan have come to a complete stop.

VACUUM CLEANER BAGS.

The Kirby Heritage™ features two vacuum cleaner bag systems: the standard disposable filter bag system, and the optional reusable bag system.

Disposable Filter Bag System. (Standard)

How to change bags.

Before you begin, unplug the cleaner's electrical cord from **1** wall outlet.

Unzip the cloth bag **2** at rear of cleaner.



3 To remove used bag, grip the top tab on the cardboard plate, pull back and lift out.

4 To replace, slide new bag into outer cloth bag, making sure the cardboard plate faces the right of the bag.



5 Hold the top tab on the cardboard plate while hooking the bottom of the opening under the lower lip of the bag retainer. Once the bottom is secure, pull the top tab up and over the upper lip of retainer.



6 Your bag should now be snapped into place—check to make sure the cardboard plate is fully on the bag retainer.

7 Zip the cloth bag closed.
NOTE: When changing the disposable filter bag, empty the Sani Em-Tor of any large particles which may have settled there.

For best results: Do not overload bag past the fill line (marked with a dotted line). Never reuse filter bags—this could damage the cleaner. Periodically check to make sure the air passage openings to the filter bag are not blocked. **For peak efficiency and performance, use genuine Kirby replacement parts.**

VACUUM CLEANER BAGS.



Reusable Bag System. (Optional)

The **Sani Em-Tor** and **Sani-Pocket** are patented Kirby features that enable easy and efficient emptying of the reusable cloth filter bag.

Emptying the Filter Bag.

- 1** Spread newspaper on the floor and place Kirby on it.
- 2** Detach wire loop on top end of the bag from handle bracket. Tilt handle back slightly. Push bag top toward handle and lift loop out of bracket.



3 Lower rug nozzle to No. 1 position (as shown) and turn on motor.

4 Allow motor to run briefly and then turn off. While bag is still extended, shake it vigorously from the top.



5 Tilt Kirby slightly and rotate side lever fully to release bottom cover of **Sani Em-Tor**. In the "open" position the lever will point to the rear of the Kirby.

CAUTION!
Unplug the cord.

Swing cover out from under **6**
Sani Em-Tor and turn cover upside
down, emptying the dirt and lint onto
the paper.

After all dirt has been removed, swing **7**
cover back into place and lock securely
with locking lever. Make sure that cover
gasket is free of dirt and that lever handle
is fully rotated.

If excessive dirt and lint has accumulated in the
bag, and does not fall readily into the **Sani**
Em-Tor, use the following procedure.



Open zipper at rear of bag and place hand inside
Sani-Pocket, grasping **Sani-Scraper** at bottom.

Scrape sides of bag with **Sani-Scraper** in
downward strokes.

Using **Sani-Scraper**, push excess lint and dirt
into **Sani Em-Tor**.

Empty as in "5" through "7" above.

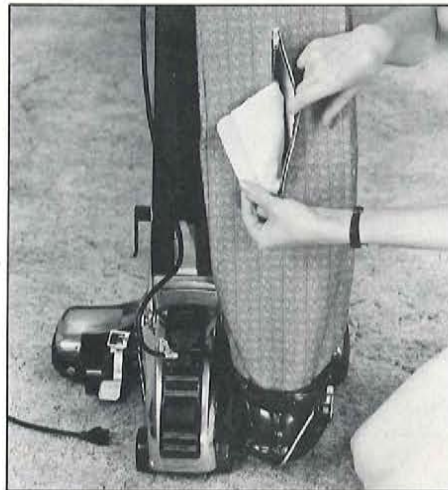

UPRIGHT CLEANER.



Carpet Vacuuming.

Upright Cleaning.

It's important to have the rug nozzle height set properly to get the most efficient cleaning action. Start out with the Toe-Touch control (30) adjusted to the full up (number 8) position. Then, by pressing your toe downward on the upper part of the Toe-Touch Control, lower the nozzle one step at a time until you notice a change in the sound of the power plant. This indicates that the nozzle is in contact with the rug and ready to clean. Any position lower than this will restrict proper air flow and reduce belt life.



Sweeping Pattern.

For the best and easiest cleaning action, push the machine straight away from you and pull it straight back. Change the direction of the machine at the end of the pull back and point it in the direction of the next sweeping path. Continue to do this across the entire rug with slow, gliding motions. Do not jerk or tug the cleaner rapidly on back stroke or when changing directions.



Handle Positions.

When the handle stop latch (28) is pushed to the left a pin extends. This pin will stop the handle from being lowered back to the horizontal. It will lock the handle in the horizontal position for storage, if it is extended with the handle down.

When the pin is out and the handle is upright, pulling back on the handle will cause the front of the machine to tilt up so that it can be moved over obstacles, such as carpet strips or throw rugs.



Straight suction cleaning.

By converting the Kirby upright into a straight suction cleaner, you can easily vacuum bare floors and short pile carpeting.



Cord Release.

To release cord, turn down the upper cord hook on the handle. Cord will drop free into your hand.



Converting to a straight suction cleaner.

1 Raise the headlight hood and turn the Belt Lifter (16) fully counterclockwise. Check the instruction label on top of the rug nozzle to be sure that the belt is disengaged.



2 Lower the headlight hood against the Belt Lifter. With the belt disengaged the brush roll will not turn and the Kirby becomes a straight suction cleaner.

MATTRESS CLEANER.



It takes just a few steps to convert your Kirby Heritage into a hard-working mattress cleaner.

Converting to a Mattress Cleaner.

WARNING:

Before changing units or attachments, unplug power cord from wall outlet, and be sure motor and fan have stopped.

- 1** Unhook clip on top (27) of handle. Pull power cord from the bracket on the back of the handle grip. Release it from the handle fork rear cover clips.



- 2** Pull handle pin (12) all the way out and lift handle off the cleaner.



- 3** Slide portable handle into the handle channel on the power plant. Push handle pin back in to fasten the portable handle to the power plant. Be sure pin goes through the holes on both sides of the portable handle.



- 4** Slide Handle Stop Latch (28) fully in direction of arrow to lock portable handle in place.
- 5** Slide bag clip (27) over any flat surface on portable handle.

Raise the headlight hood (19) and
turn the Belt Lifter fully counter-**6**
clockwise. With the belt disengaged the brush
roll will not turn and the Kirby becomes a
straight suction mattress cleaner.



TANK CANISTER CLEANER.



Attaching the hose.

To use the above-the-floor tools, the flexible hose must be attached to the front of the Kirby.

WARNING:

Before changing units or attachments, unplug power cord from wall outlet, and be sure motor and fan have stopped.

- 1 Move the Toe-Touch Control (30) to the Number 8 position. Then raise headlight hood.



- 2 Turn the Belt Lifter (16) counterclockwise, or all the way to the left until it stops. (See instruction label at top of nozzle.)



- 3 Unlock the accessory lock (17) that's located under the hood by moving it all the way to the left. Rug nozzle should drop forward slightly.



- 4 Remove rug nozzle (15) by lifting it up slightly and pulling it toward you. Now you are ready to install the hose.



5 Hook the attaching lugs of the large coupling on the flexible hose over the ends of the attaching bar (14) on the power plant and swing the hose coupling end up against the power plant.

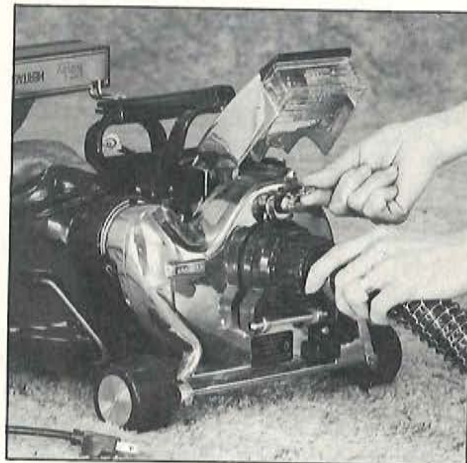

6 Rotate the accessory locking lever (17) until hose connector is tightly closed and sealed against power plant. Close the headlight hood.

The Kirby is now ready for above-the-floor cleaning and is ready to accept any of the hose attachments that come with your Kirby.

How to attach tools to the hose.

1 To attach tools, push lightly while twisting the connection of the smaller end of the hose into the desired tool.

2 Extension tubes and swivel elbow are assembled in the same manner. To avoid breakage, do not jam or force the coupling ends into the attachments.



ATTACHMENTS.



The Crevice Tool.

For deep cleaning in crevices, cracks, corners, grooves, narrow openings, and behind seat cushions of upholstered furniture, attach the crevice tool without the removable brush to the flexible hose or to the extension tubes.

With the removable brush placed in the end of the crevice tool, you have a cleaning tool that removes dirt from corners, between radiator coils, venetian blinds, and sliding window tracks.



Utility Brush Nozzle.

Attach to end of extension tubes and use for cleaning walls, ceilings and large flat surfaces.



The Duster Brush.

Attach the duster brush to the end of the flexible hose or to the extension tubes and you can remove dust from any surface, including those with contours, such as moldings or delicate lamp shades and unusual shapes.



Portable Shoulder Strap.

The shoulder portable is ideal for cleaning in areas where considerable mobility and freedom of hands is required.

Remove the carrying strap from the attachment case and clip the spring clip on each end into the holes at front and back of the portable handle.

Slide the adjusting buckle on the carrying strap so the portable cleaner rests comfortably on your shoulder.

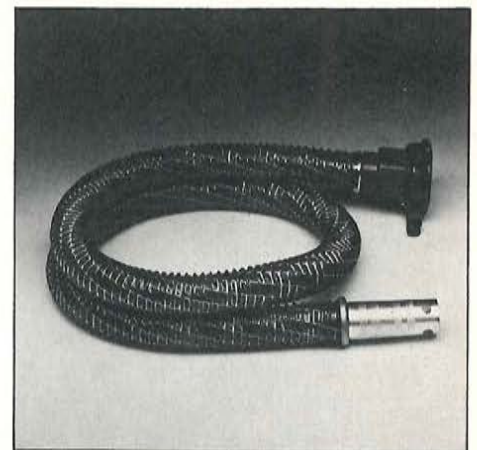

Storing the Flexible Hose.

Never store the flexible hose near a heat source. Keep it in a cool, dry place and never hang it on a sharp hook or nail. Store it in a place where it will be readily available.

TURBO BRUSH.

Turbo Brush.

Ideal for deep cleaning of carpeting and stair treads, as shown.

For maximum cleaning efficiency, keep base plate of Turbo Brush level with the surface being cleaned. The rotating brush may cause particles to be thrown from rear of base plate, if not held level. To reduce suction when vacuuming draperies, clothing, etc., open slide valve (32). Do not insert fingers in open slide valve.

WARNING

Keep hair, clothes, face and fingers away from rotating brush. Disconnect unit from Kirby before servicing.



Turbo Brush.

This unique portable cleaner makes difficult hand vacuuming jobs easy. Turbo Brush uses a mechanical brushing action to do a thorough cleaning job on carpeted stairs, upholstery, drapes—anywhere an upright cleaner can't be used.

CAUTION: When using the Turbo Brush, keep it moving across the surface to be cleaned. Do not let it remain in one place.



Extension Wands.

Attaching the curved extension tube to the hose, the straight extension tube to the curved tube, the swivel tube to the straight tube, and the surface nozzle to the swivel gives you maximum reach.

Attaching the hose to the straight tube and adding the curved extension tube on the straight extension tube and utility brush nozzle makes an effective wall, ceiling, and baseboard cleaning arrangement.



Surface Nozzle with Swivel Attachment.

The surface nozzle with brush extended is for use on carpeted floor areas. It has a lever on the front of its housing which allows you to raise or lower the brush. The up position of the brush is recommended for the cleaning of deep pile or loose throw rugs.

SERVICE TIPS.

Your Kirby has been designed and manufactured to give you many years of normal in-home usage with relatively little maintenance required.

The Kirby motor has permanently lubricated and sealed ball bearings and will not need lubrication. If bearings become noisy, repair of the motor must be done only by authorized qualified Kirby service personnel.

To maintain your Kirby in good, serviceable condition, it should be inspected periodically by an authorized Kirby service person.



Headlight bulb replacement.

1 Raise the headlight hood on the power plant. With a Phillips head screwdriver, loosen the two screws that hold the headlight lens to the hood.

2 Unplug the lens and socket assembly from the terminal block. Replace the bulb, plug in the lens and socket assembly, and replace the screws.

NOTICE. All service and maintenance required other than those things described in this book should be done by authorized qualified Kirby service personnel using genuine Kirby replacement parts.

WARNING.

Before servicing, always unplug power cord from wall outlet and be sure the motor and fan have come to a complete stop.

WARNING

Remove Turbo Brush from unit before servicing. Beware of sharp objects that may become lodged in brush.

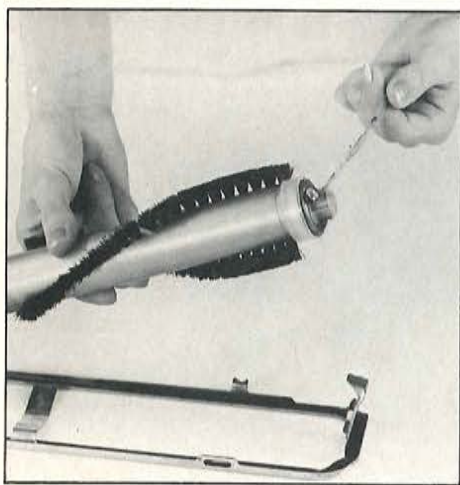

Brush cleaning of Rug Nozzle.

Keep the brushes and belt track clear of lint, string, hair, and other fibers. Pay particular attention to keeping these fibers away from the bearings at the ends of the brush roll.

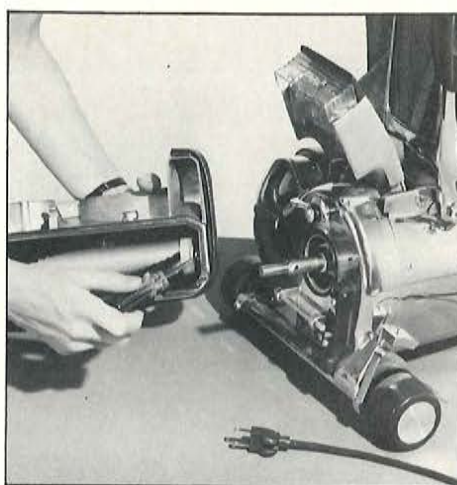

Brush adjustment of Rug Nozzle.

After the rug nozzle has been in use for some time, the brush bristles may begin to wear. To adjust the brush height, place the rug nozzle on a table. Place a straight edge on the nozzle plate next to brush tufts to see

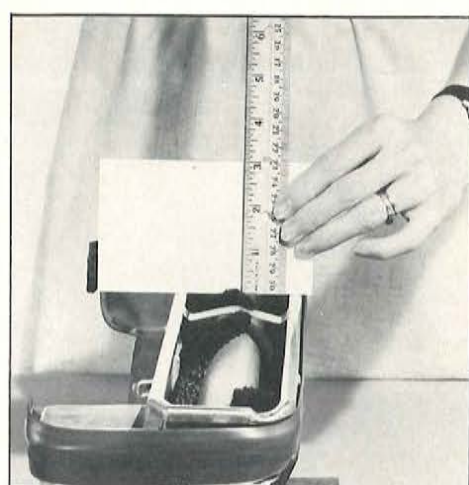

protrusion. Turn both screws clockwise an equal amount until the brushes protrude about 1/16 inch past the rug plate. One full turn of these screws moves the brush out about 1/32 inch. Make certain brush roll is kept parallel with rug plate or belt will not center between tufts.

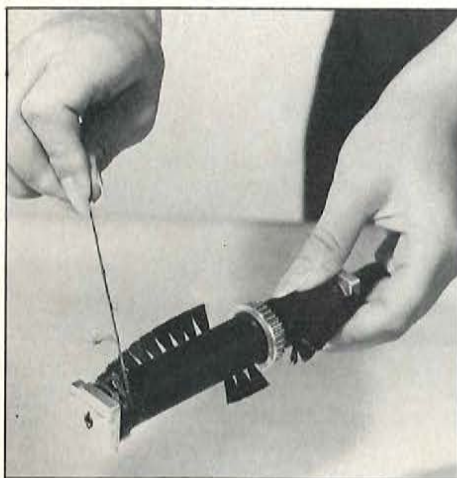

Brush cleaning of Turbo Brush.

Remove base plate by sliding bottom latch back. Clean turbine and/or brush, then replace base plate by inserting tabs into slots on front of unit attaching at bottom latch.

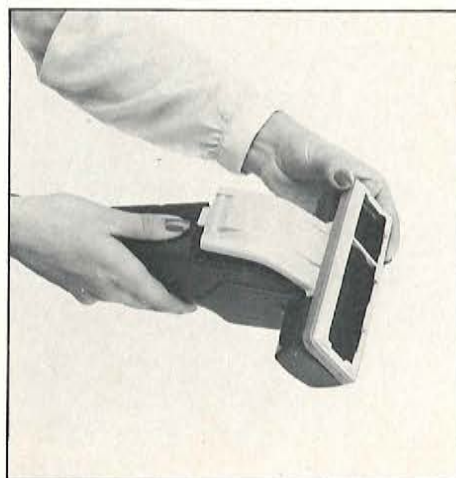

Brush adjustment of Turbo Brush.

To adjust brush to compensate for bristle wear, remove base plate by sliding bottom latch back. Next, remove the belt cover (33) by removing the screw. Finally remove the belt from the pulley. (An aid to belt removal is to turn brush backwards slightly.) Pull the brush assembly out. Turn brush assembly over and re-insert



so that number "1" is showing at both ends.

NOTE: The brush roll comes from the factory with a "2" showing at both ends of the brush roll assembly.

When adjusting brush, make sure no brush bristles are caught between belt and brush roll gear.

CAUTION: Do not operate with belt cover (33) removed.

SERVICE TIPS.

Belt replacement for Rug Nozzle.

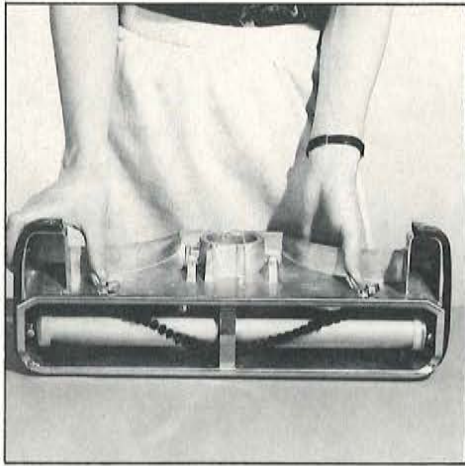

1 To replace the belt in the rug nozzle, remove the nozzle from the motor and place the nozzle on a table.

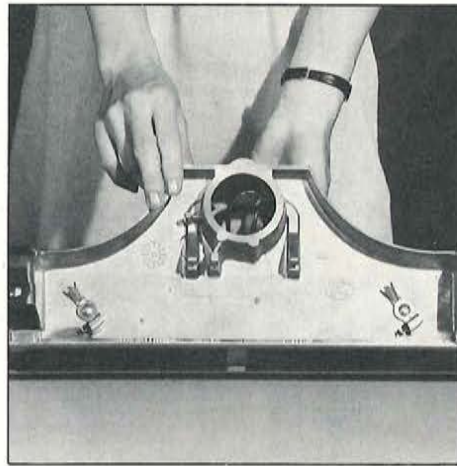

2 Turn the Belt Lifter all the way clockwise until the belt drops off the finger inside the nozzle. Turn nozzle upside down. Unlock rug plate by means of two latches on rear of nozzle.



3 Pull up on rear of rug plate to pull brush roll and plate out of nozzle.

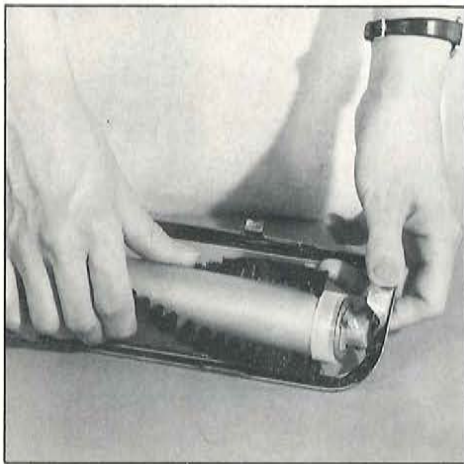

4 Bend slightly one end bracket of the rug plate away from one end of brush.

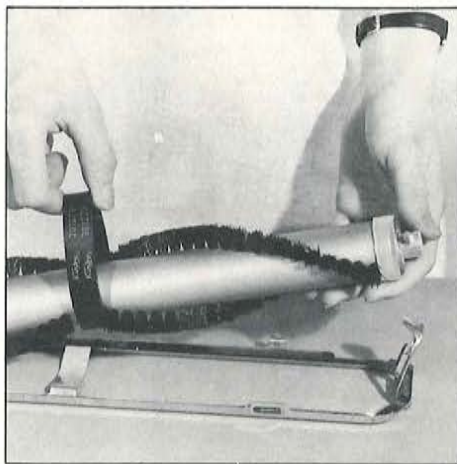

5 Slide the belt off the roll and slide on a new belt. The new belt must be in the middle of the roll. Place the roll back into the end bracket with the screw heads facing the openings in rug plate.



6 Hook rug plate on front of nozzle and rotate it back against nozzle opening and make certain it fully closes against nozzle. Rotate latches to lock plate in place, and center belt under rug plate center rib. Turn the Belt Lifter counter-clockwise until the finger in the nozzle picks up the belt.

NOTE: If the entire roll is removed, be careful to replace the roll exactly as it came out. The silver end of the brush roll is on your left as you face the front of nozzle.

Belt replacement for Turbo Brush.

WARNING

Remove Turbo Brush from unit before servicing.

Remove base plate by sliding bottom latch back and belt cover (33) by removing screw. Next, remove belt from pulley (may help to turn brush backwards slightly). Pull belt and brush assembly out and replace belt. Before replacing base plate and belt cover, make sure a "2" is showing at both ends

Troubleshooting.

Many service calls are unnecessary. Checking a few simple things can save a lot of cost, time and trouble. Whenever your Kirby does not perform properly, make these checks first before calling authorized service personnel.

If the motor does not start when the motor ON-OFF switch is pushed:

1. Make sure the power cord is plugged into an outlet and that the outlet has power. (Check for tripped circuit breaker or power company trouble.)
2. Make sure the cord plug is fully inserted into the cleaner.
3. Look for breaks in the power cord insulation. If the cord is damaged, get a new one. **DO NOT ATTEMPT TO REPAIR IT.**
4. Make sure that an attachment or accessory is properly mounted on the front of the power plant.

If the Kirby does not pick up lint or litter on the carpet:

1. Make sure that the belt is on the brush roll and on the power plant drive pulley.
2. Make sure that the belt is not broken or slipping. Replace if



of brush roll assembly, and no brush bristles are caught between the belt and brush roll gear. If brush roll bristles are worn, see brush adjustment instructions on page 19.

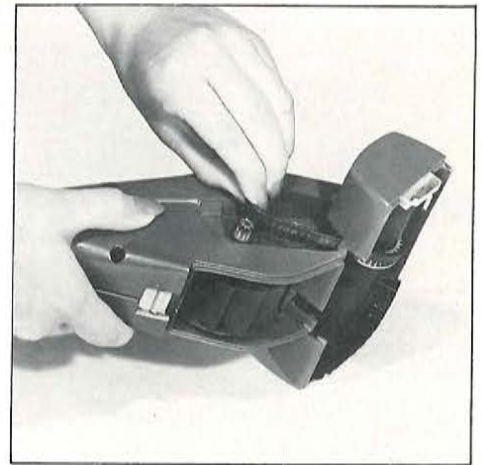

If the Sani Em-Tor is loose:

1. Make sure it locked in position.
2. Make sure the rubber gasket inside the collar of the **Sani Em-Tor** is properly in place; dirt will blow out if it is not. Replace if the **Sani Em-Tor** gasket is missing or damaged.

If the brush roll in any accessory does not turn:

1. Make sure the belt is not broken or worn out.
2. Make sure the belt is in place around the brush roll and on the power plant pulley.
3. Check to see if brush roll can be rotated.

If the Kirby is hard to push when the rug nozzle is attached:

1. Make sure the nozzle is not set too low. Raise the Toe-Touch control one or two notches.
 2. Make sure that the belt is on the brush roll and on the power plant drive pulley.
 3. Make sure that the belt is not broken or slipping. Replace if necessary.
5. Check to see if rug plate on carpet nozzle is properly attached and latched.
 6. Make sure that the Toe-Touch control is adjusted to place the nozzle in contact with the rug.
 7. Make sure the brush roll is adjusted properly and the bristles are not worn out. 1/16 inch of tuft should extend out of nozzle plate. Check with ruler against nozzle. Replace or adjust as required.
 8. Make sure bag is not full.
 9. Check to be certain that fill tube and **Sani Em-Tor** are not clogged.

The sign of Kirby quality.

Whenever you require service or desire to purchase one of the many accessories available for your Kirby Heritage™, look for **this sign** of the Authorized Kirby Distributor. You'll find it on his store front and in your telephone Yellow Pages. It's your assurance of qualified service and expert assistance.



Owner Registration.

To register for your Kirby Rebuilding Agreement, please complete the Owner Registration card that is packaged with your cleaner. To insure proper registration, check to see that the serial number on your cleaner corresponds with the number on the card.

Important Notice.

The Kirby Company provides a valuable rebuilding service for the owner of a Kirby purchased from an Authorized Kirby Distributor, when the unit is purchased for personal, family, or household use. To register for that service, make sure that your Rebuilding Agreement Card has been properly filled out and signed by the salesperson at the time of sale, and a copy has been left with you. Keep that card in a safe place.

THE SERIAL NUMBER ON YOUR MACHINE SHOULD MATCH THE SERIAL NUMBER AT THE UPPER RIGHT CORNER OF THE CARD.

That Kirby Rebuilding Agreement, and the Limited Warranty which is described on the opposite page, are each null and void if the name plate or serial number of the Kirby has been defaced, removed, or changed (other than by fire or other casualty or accident, or in connection with the factory rebuild) and the Kirby Rebuilding Agreement is null and void if the Kirby was not purchased from an independent authorized Kirby distributor, or dealer who signed the Rebuilding Agreement Card and filled in the date and serial number.

PROTECT YOUR RIGHTS: IN ORDER TO ASSURE THE VALIDITY OF YOUR REBUILDING AGREEMENT, MAKE SURE YOU ARE

1. PURCHASING FROM AN INDEPENDENT AUTHORIZED KIRBY DISTRIBUTOR OR DEALER;
2. THE REBUILDING AGREEMENT CARD IS FILLED IN AND SIGNED;
3. THE ORIGINAL NAME PLATE AND SERIAL NUMBER ARE INTACT.

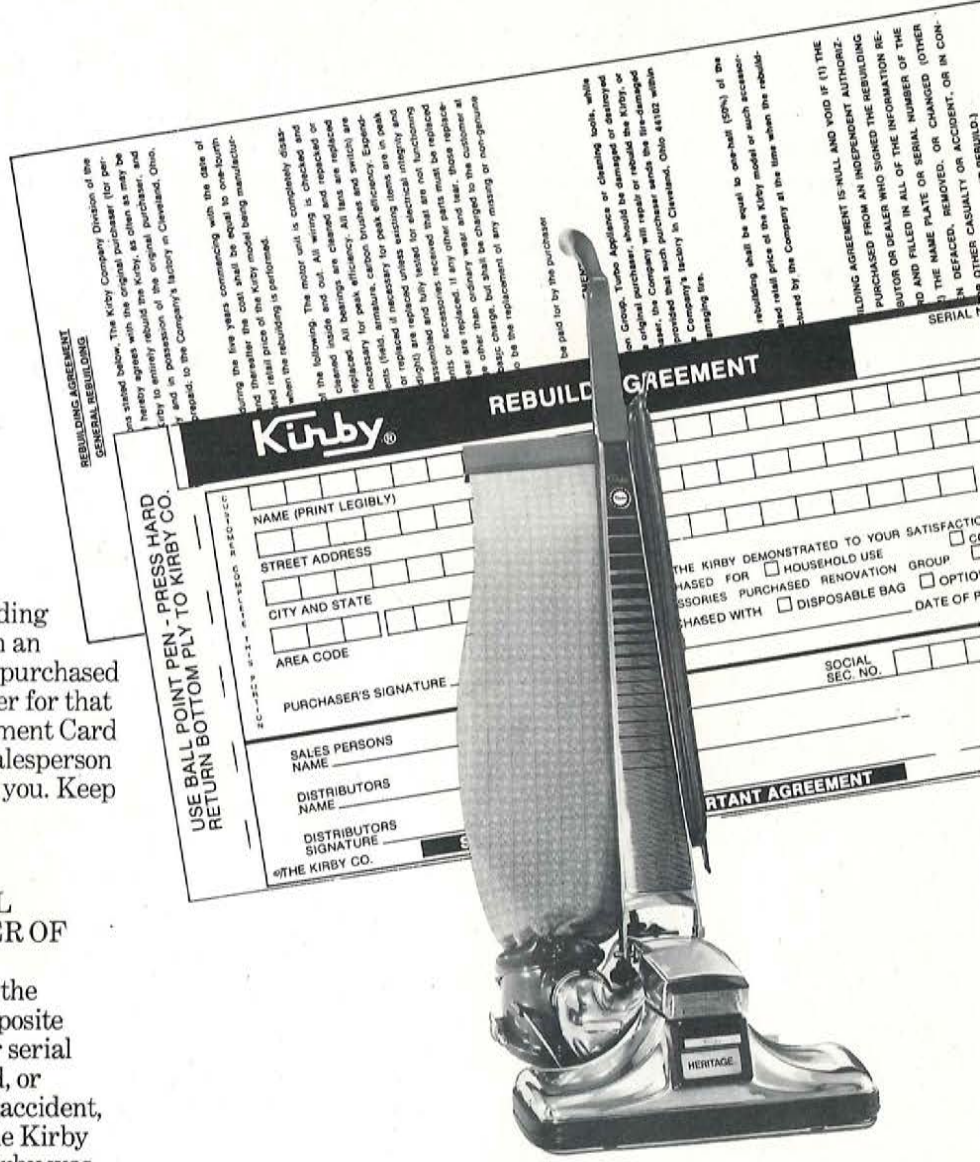

REBUILDING AGREEMENT

GENERAL REBUILDING

The Kirby Company, Division of the Kirby Company, Inc., is pleased to provide this rebuilding service to you. The Kirby Company, Inc. is pleased to provide this rebuilding service to you. The Kirby Company, Inc. is pleased to provide this rebuilding service to you.

USE BALL POINT PEN - PRESS HARD RETURN BOTTOM PLY TO KIRBY CO.

Kirby REBUILDING AGREEMENT

NAME (PRINT LEGIBLY) _____

STREET ADDRESS _____

CITY AND STATE _____

AREA CODE _____

PURCHASER'S SIGNATURE _____

SALES PERSONS NAME _____

DISTRIBUTORS NAME _____

DISTRIBUTORS SIGNATURE _____

DATE OF PURCHASE _____

SOCIAL SEC. NO. _____

IMPORTANT AGREEMENT

THE KIRBY DEMONSTRATED TO YOUR SATISFACTION FOR HOUSEHOLD USE COMMERCIAL USE

ACCESSORIES PURCHASED RENOVATION GROUP OTHER

REBUILT WITH DISPOSABLE BAG OPTION _____ DATE OF PURCHASE _____

LIMITED WARRANTY.

Subject to the conditions and exceptions stated below, The Kirby Company ("Company") warrants to the original purchaser (OTHER THAN FOR PURPOSES OF RESALE) that each Kirby product shall be free from defects in material and workmanship, under normal use and service, as follows: (a) for two (2) years from the date of purchase by the original purchaser when used for personal, family, or household purposes ("consumer purposes"); (b) for one (1) year from the date of purchase by the original purchaser when used for commercial, professional, rental, institutional, etc., purposes ("commercial purposes"); (c) for one (1) year from the date of any factory repair or rebuild provided to the original purchaser under the terms and condition of the KIRBY REBUILDING AGREEMENT. During the applicable warranty period, the Company will furnish for the Kirby product a replacement part for any part found to be defective, through an authorized Kirby Distributor. All transportation expenses must be borne by the purchaser. This Limited Warranty does not apply to motor brushes, belts, light bulbs or other expendables, such as buffing pads, compounds, etc., charges for labor or service calls, damage caused by accident, misuse, negligence, abuse, or to any Kirby product which has been repaired so as in the judgment of the Company to affect its stability or reliability, or in which parts not approved by the Company shall have been used. In approving the Kirby for double insulation, UNDERWRITERS' LABORATORIES REQUIRES THAT ONLY IDENTICAL PARTS SHOULD BE USED IN SERVICING THE SEALED MOTOR UNIT.

The foregoing provisions state the exclusive remedy for any breach of warranty or any other claim in respect of any Kirby product. THERE IS NO OTHER EXPRESS WARRANTY, IMPLIED WARRANTIES, INCLUDING THOSE OF MERCHANTABILITY AND FITNESS FOR A PARTICULAR PURPOSE,

ARE LIMITED TO TWO (2) YEARS FROM THE DATE OF PURCHASE BY THE ORIGINAL PURCHASER, IN THE CASE OF KIRBY PRODUCTS USED FOR CONSUMER PURPOSES; TO ONE (1) YEAR FROM THE DATE OF ANY FACTORY REBUILD PROVIDED TO THE ORIGINAL PURCHASER UNDER THE TERMS AND CONDITIONS OF THE KIRBY REBUILD AGREEMENT; AND TO ONE (1) YEAR FROM THE DATE OF PURCHASE BY THE ORIGINAL PURCHASER, IN THE CASE OF KIRBY PRODUCTS USED FOR COMMERCIAL PURPOSES; AND ANY IMPLIED WARRANTY OF FITNESS FOR COMMERCIAL USE IS HEREBY DISCLAIMED. THIS IS THE EXCLUSIVE REMEDY, AND ANY LIABILITY FOR INDIRECT OR CONSEQUENTIAL DAMAGES OR FOR ANY INCIDENTAL EXPENSES, IS EXCLUDED. Some states do not allow limitations on how long an implied warranty lasts, or do not allow the exclusion or limitation of incidental or consequential damages, so the above limitations may not apply to you.

The Company neither assumes or authorizes any other person to assume for it, any additional liability in connection with the sale of its products.

THE LIMITED WARRANTY IS NULL AND VOID IF THE NAME PLATE OR SERIAL NUMBER OF THE KIRBY HAS BEEN DEFACED, REMOVED, OR CHANGED (OTHER THAN BY FIRE OR OTHER CASUALTY OR ACCIDENT, OR IN CONNECTION WITH A FACTORY AUTHORIZED REBUILD).

This Limited Warranty gives you specific legal rights, and you may also have other rights which vary from state to state.

Service calls and labor costs, including those during the warranty period, will be at the expense of the owner.

The Kirby logo is rendered in a stylized, bold, brown font. The letters 'K' and 'I' are connected, and the 'y' has a distinctive shape with a horizontal bar at the bottom. A registered trademark symbol (®) is located to the right of the 'y'.

ACCESSORIES.



Heritage™ Super Renovation Group.

Rug Renovator. Your own personal carpet shampooing system. Easily attaches to your Kirby—gently and thoroughly deep-cleans your carpeting with low-moisture, controlled sudsing.

Inflator/Deflator. Handy attachment inflates low pressure inflatable toys and air mattresses up to one P.S.I. (pounds per square inch). Also used to remove all air from these items.

Air Intake Guard. Operates Sprayer/Suds-O-Gun and Inflator/Deflator. Attaches to Kirby power plant.

Sprayer/Suds-O-Gun. Sprayer is ideal for watering plants with fine mist—also for spray painting with non-flammable paint.

Suds-O-Gun expertly cleans color-fast upholstery.

Floor Polisher and Carpet Fluffer. Rug Renovator converts easily to a dual purpose appliance for polishing waxed floors or raising carpet pile.

DANGER: Do not use with flammable cleaning fluids.

Instant Suds (12 oz. bottle). Deep-cleaning suds formula that prevents resoiling. Specially formulated for use with Rug Renovator and Suds-O-Gun.



Heritage™ Handi-Butler® Group.

A versatile attachment that creates a portable workshop in your home. Ideal for a variety of household jobs—buffing, sanding, drilling, polishing.

ACCESSORIES.

Heritage™ Home Turbo Group.

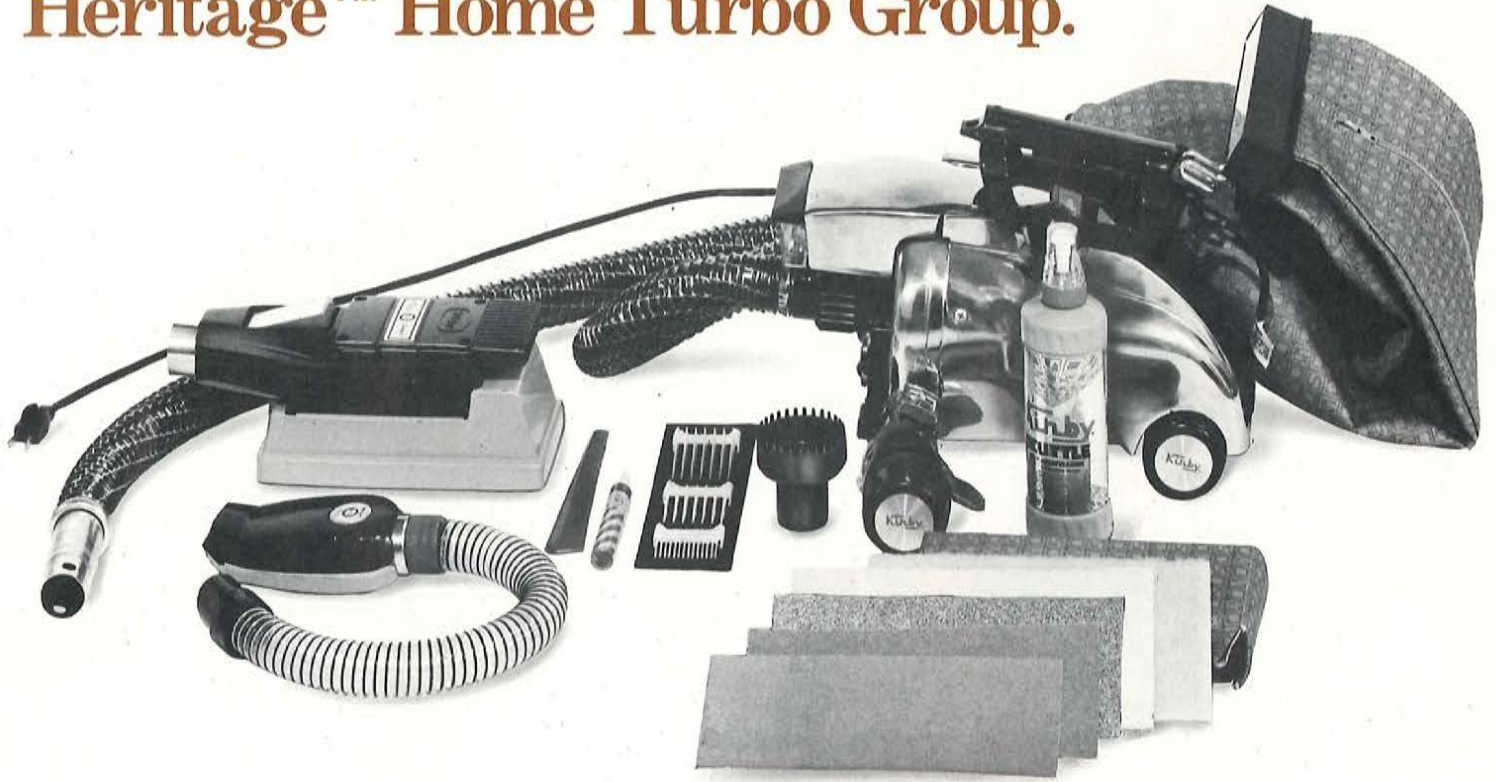

Turbo-Sander. A versatile sander that efficiently vacuums all sawdust, letting you sand all kinds of items right in your home with no mess. Also works as a massager or scrubber/buffer—with appropriate pads.

Turbo-Groom. A modern hair groomer that vacuums hair clippings before they hit the floor—minimizing clean-up. Comes with attachments to achieve professional results.

Massage Cup. Provides invigorating massage action for scalp or skin. Removes loose hair while grooming pets.

And other Fine Kirby Products...



Scuttle. Makes cleaning as easy as spray on-wipe off. Perfect for windows, walls, chrome, woodwork, stainless steel, appliances, almost any washable surface.

Room and Carpet Home Freshener. Fast-working powered room freshener sprinkles on carpet—vacuums up in seconds. Delightful lemon scent.

Handi-Waxer and Wax. An efficient floor waxer used to apply Kirby Handi-Waxer wax. Uses extension wands from the Kirby cleaner for a handle. Handi-Waxer wax brings a lustrous, deep-gloss shine to tile, linoleum, vinyl, many other floor surfaces. Specially formulated for use with the Handi-Waxer.

Odorific. All-purpose deodorizer eliminates household odors instantly, economically up to 24 hours with only a drop.

Instant Suds. A product with a combination of cleaning power, resoiling resistance and fabric brightener makes it an outstanding rug and upholstery shampoo.

Touch-up Paint. A special touch-up paint that will keep the finish of your Kirby looking like new. Packaged in a convenient 3-pack.

Replacement Belts. Kirby replacement belts for your rug nozzle and Turbo-Brush to keep your system operating at peak efficiency.

Disposable Filter Bags. These bags are a must for your Kirby disposable bag cleaning system. Packaged in 3 and 12 packs.

WARNING.

Please keep these products
out of the reach of children.
May cause irritation
if swallowed or placed in eyes.

Kirby Care Kit.

Kit includes everything needed to remove common spots and stains from upholstered furniture and carpets.

INDEX.

A

- Above Floor Cleaning 14, 15, 16
- Above Floor Tools 4, 13, 14, 15, 16
- Accessories 24, 25, 26
- Accessory Lock 3, 14, 15
- Air Outlet 3
- Attaching Bar 3, 15
- Attaching Lugs 15
- Attaching Tools to Hose 15
- Attachment List and Explanation 4

B

- Bag Guard 3
- Belt Lifter 11, 14
- Belt Replacement**
 - Floor Nozzle 20
 - Turbo Brush 21
- Brush**
 - Crevice Tool 4, 16
 - Surface Nozzle 4, 17
 - Turbo Brush 4, 17
- Brush Adjustment**
 - Rug Nozzle 19
 - Turbo Brush 19
- Brush Cleaning**
 - Rug Nozzle 19
 - Turbo Brush 19
- Brush Roll**
 - Rug Nozzle 19
 - Turbo Brush 19
- Bumper Rug Nozzle 3

C

- Cannister Flexible Hose 4, 15, 16
- Carpet Vacuuming 10, 11
- Changing Disposable Bags 3, 7
- Cloth Filter Bag 3, 7, 8
- Cloth Filter Bag Hanger 3, 8
- Controls 3
- Converting to**
 - Deep Cleaning Portable Cleaner 17
 - Straight Suction Cleaner 11
 - Straight Suction Mattress Cleaner 12
 - Tank Cannister Cleaner 14, 15
- Cord 3, 12, 14, 18, 21
- Cord Clip 3, 12
- Crevice Tool 4, 16
- Crevice Tool Brush 4, 16
- Curved Extension Tube 4, 16

D

- Deep Cleaning Portable 17
- Disposable Bag**
 - Changing 7
 - Top Fill Hose 7
- Disposable Bag System 3, 7
- Disposable Vacuum Bags 3, 4, 27
- Duster Brush 4, 16

E

- Emptying Cloth Bag 8, 9
- Emptying Sani Em-Tor 8, 9
- Extension Wands 4, 17

F

- Flexible Hose 4, 15, 16
- Flexible Hose Storage 16
- Foot Switch 3
- Freshener, Room and Carpet 4, 27

H

- Handle Channel 12
- Handle Grip 3
- Handle Pin 3, 12
- Handle Positions 10
- Handle Stop Latch 3, 10
- Headlight Bulb Replacement 18
- Headlight Hood 3, 11, 14, 18
- Height Adjustment 10
- Heritage™ Handi-Butler Group 25
- Heritage™ Home Turbo Group 26
- Heritage™ Super Renovation Group 24
- Horizontal Handle Position 10
- Hose 4, 15, 17
- Hose Connector 15

I

- Important Safeguards 6
- Instant Suds 27

K

- Kirby Care Kit 27

L

- Limited Warranty 23

M

Mattress Cleaner	
Converting to	12
Handle	4, 12
Mounting	
Attachments	15
Flexible Hose	14, 15

O

Odorific	4, 27
Owner Registration	22

P

Parts List and Controls	3
Power Cord	3, 12, 14, 18, 21
Power Plant	3

R

Rebuilding Agreement	22
Removing Rug Nozzle	14
Repair and Service	18, 19, 20, 21
Reusable Bag System	3, 8, 9
Room and Carpet Freshener	4, 27
Rug Nozzle	
Belt Replacement	20
Brush Adjustment	19
Brush Cleaning	19
Brush Height	10
Brush Mounting	20
Brush Roll	20
Rug Plate	20
Rug Renovator	24

S

Safety	6
Sani Em-Tor	8, 9
Sani Pocket	9
Sani Scraper	9
Scuttle	27
Service and Repair	18, 19, 20, 21
Service Tips	18, 19, 20, 21
Shoulder Portable	16
Shoulder Strap	4, 16
Standard Attachments List	4
Stop Latch	3, 10
Storing Flexible Hose	16
Straight Extension Tube	4, 17
Straight Suction Cleaner	11
Straight Suction Cleaner Conversion	11
Surface Nozzle with Swivel Attachment	4, 17
Sweeping Pattern	10
Swivel Attachment	4, 17

T

Table of Contents	5
Tank Cannister	14, 15
Toe Touch Control	3, 8, 10, 14
Trouble Shooting	21
Turbo Brush	4, 17
Turbo Brush	
Belt Replacement	21
Brush Adjustment	19
Brush Cleaning	19
Turbo Groom	26
Turbo Sander	26

U

Upper Cord Hook	3
Upright Cleaner	10, 11
Upright Handle	3, 10

V

Vacuum Cleaner Bag Systems	7, 8, 9
Vacuum Height Adjustment	8, 10, 14

W

Warnings	6, 8, 17, 18
Warranty	23

The Kirby Company[®]

A SCOTT & FETZER GROUP
CLEVELAND, OHIO 44102
U.S.A.

Form # 260081 Rev. A (U.S.A.)
Printed in the U.S.A.

Use & Care of the **HERITAGE™** **CONVENIENCE** **GROUP** and other Kirby Equipment

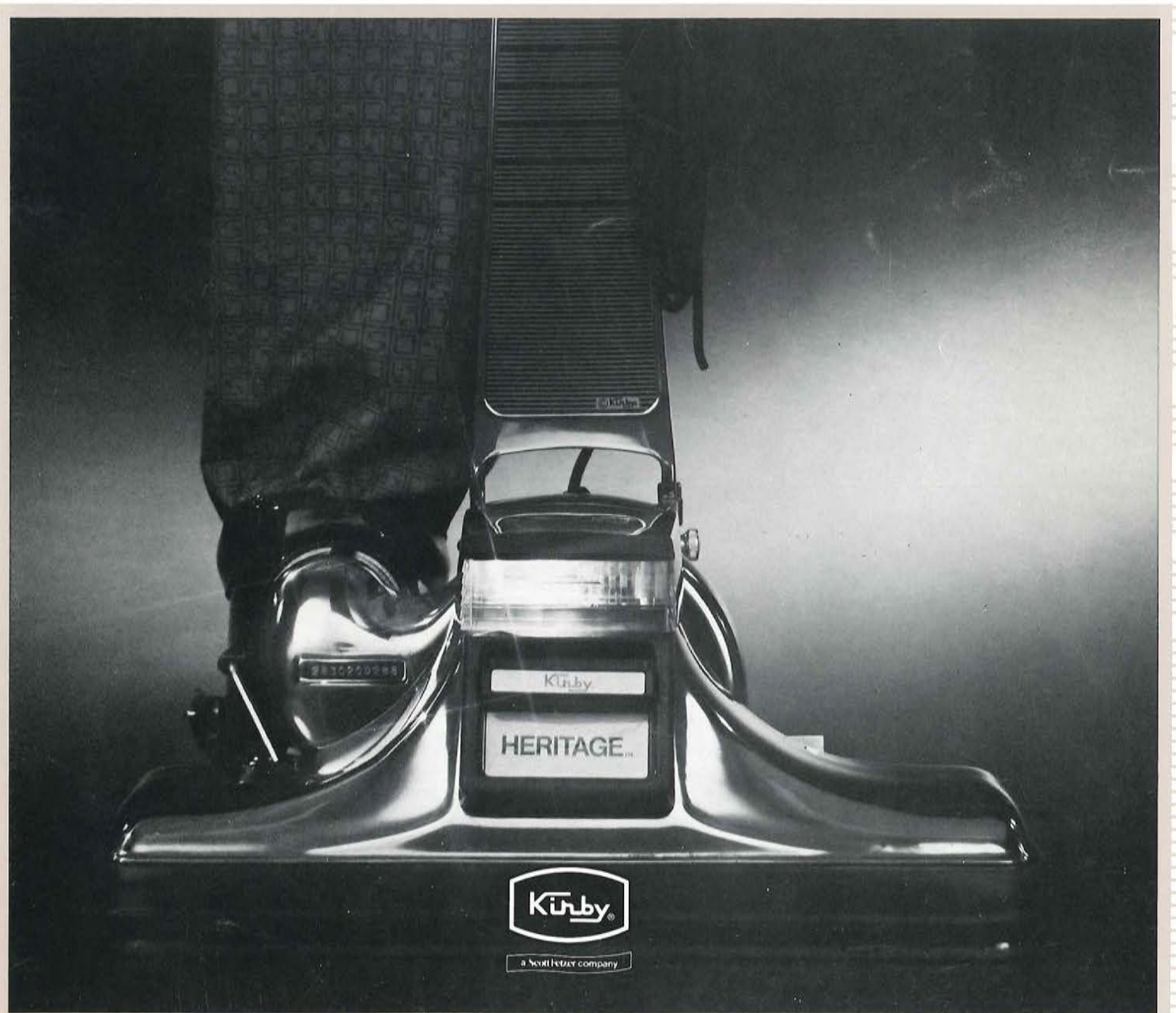

SAVE THESE INSTRUCTIONS. Important: Read all instructions, warnings and safeguards before using.

KIRBY HERITAGE™

Parts List & Controls.

Table of Contents

Parts List & Controls 2
 Important Safeguards 3
 Standard Attachments 4

VACUUM CLEANER BAGS.

Disposable Filter Bag System 5
 Reuseable Bag System 6

UPRIGHT CLEANER.

Carpet Vacuuming 7
 Straight Suction Cleaning 8

MATTRESS CLEANER.

Converting to a
 Mattress Cleaner 9

TANK CANISTER CLEANER.

Attaching the Hose 10-11

KIRBY CONVENIENCE GROUP ATTACHMENTS.

Crevice Tool, Duster Brush,
 Utility Brush Nozzle, Shoulder
 Strap and Flexible Hose, Extension
 Wands, Surface Nozzle, Inflator/
 Deflator, Air Intake Guard, Utility
 Air Nozzle, Suds-O-Gun/Spray
 Gun, Portable Handle,
 Massage Cup 12-13
 Blower Attachments 14-16
 Service Tips 17

BELT REPLACEMENT

Trouble-Shooting 18

OTHER EQUIPMENT.

Rug Renovator 19-24
 Floor Polisher
 & Carpet Fluffer 25-27
 Turbo Brush 28
 Turbo Sander 29-31
 Turbo Groom 32-34
 Limited Warranty 35

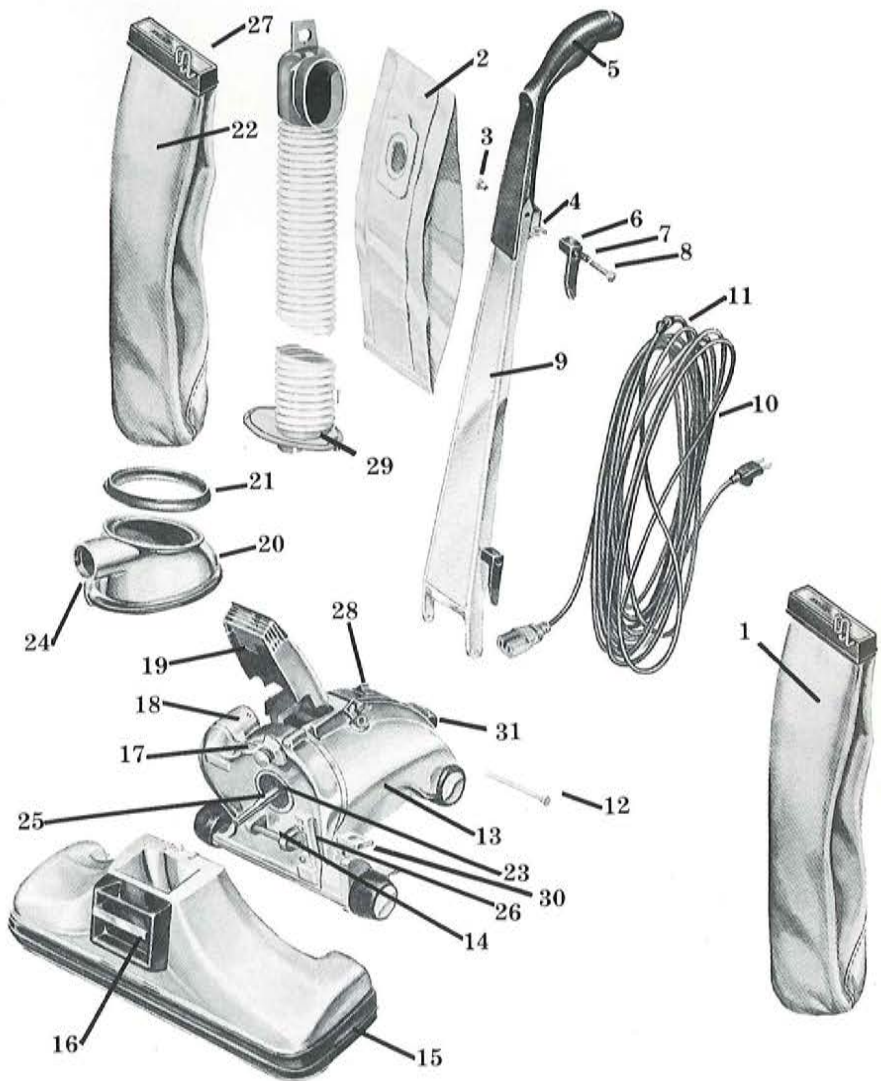

- | | |
|--|---------------------------------------|
| 1 Optional Reuseable Bag System | 17 Accessory Lock |
| 2 Disposable Paper Bag | 18 Air Outlet |
| 3 Nut | 19 Headlight Hood |
| 4 Handle Bracket | 20 Sani Em-Tor |
| 5 Handle Grip | 21 Bag Guard |
| 6 Upper Cord Hook | 22 Cloth Filter Bag and Hanger |
| 7 Spring | 23 Suction Seal Ring Gasket |
| 8 Screw | 24 Em-Tor Gasket |
| 9 Upright Handle | 25 Power Shaft |
| 10 Power Cord | 26 Speed Selector |
| 11 Cord Attaching Groove | 27 Clip on Top |
| 12 Handle Pin | 28 Handle Stop Latch |
| 13 Power Plant | 29 Disposable Bag System |
| 14 Attaching Bar | 30 Toe-Touch Control |
| 15 Rug Nozzle | 31 Foot Switch |
| 16 Belt Lifter | |

IMPORTANT SAFEGUARDS.

Read All Instructions, Warnings and Cautions Before Using!

The Kirby Heritage 1HD and 1HC are listed and certified by Underwriters Laboratories, Inc., or Canadian Standards Association respectively as 120 volts double-insulated cleaners.

WARNING

To reduce risk of electric shock, do not use outdoors or on wet surfaces.

These guidelines, and others found throughout this book, are presented for your protection and convenience. Please read them carefully, since a failure to heed these precautions could result in discomfort or injury. When using electrical appliances, especially when children are present, basic safety precautions should always be followed.

ALWAYS BE SURE MOTOR AND FAN HAVE COME TO COMPLETE STOP, AND UNPLUG CORD FROM WALL SOCKET BEFORE CHANGING ACCESSORY UNITS OR ATTACHMENTS.

DO NOT USE ANY ATTACHMENT NOT RECOMMENDED OR SUPPLIED BY THE KIRBY COMPANY, AND USE ONLY AS DESCRIBED IN THIS MANUAL.

NEVER LEAVE CLEANER UNATTENDED WHEN IT IS RUNNING OR WHEN CORD IS PLUGGED IN.

WHEN CLEANER IS RUNNING, NEVER ALLOW FINGERS, HAIR, FACE OR LOOSE CLOTHING TO COME NEAR INTAKE SUCTION PORTS, NOZZLE OR REVOLVING BRUSHES.

REPLACE DAMAGED OR WORN PARTS WITH GENUINE KIRBY PARTS IN ORDER TO MAINTAIN SAFETY AND TO PROTECT YOUR WARRANTY.

Never vacuum live fireplace ashes, cigar or cigarette butts.

Never run cleaner over power cord or place sharp objects on cord. Keep cord away from heated surfaces. Don't close door on cord or snag it under furniture or doors.

Never let invalids or children use or play with cleaner.

Use extra caution when cleaning on stairs.

Keep cleaner on floor — not on chairs, tables, etc.

When disconnecting power cord, grasp plug — not cord. Do not use cord to pull cleaner around. Do not close a door on it or snag it under furniture.

Store cleaner, attachments and accessory units promptly after each use to prevent accidents caused by tripping over power cord or equipment.

Always unplug cleaner immediately after using.

Don't use in an enclosed space where flammable, explosive, gasoline, aerosol spray products or toxic materials are stored or used or where vapors from such materials may be present.

Don't use where oxygen or anesthetics are used.

Don't use cleaner to pick up hard or sharp items such as coins, pins, nails, etc. They could damage the fan, fan housing or bag.

Never drop or insert any object into any opening of the cleaner.

Don't use cleaner, attachments or accessory units if in poor condition. Have qualified service person inspect, replace or repair whenever necessary.

Don't plug cleaner into a table lamp or light fixture.

Don't move tables, lamps, etc., while holding onto cleaner.

Check hose and cleaner suction seals and gaskets regularly. Worn, damaged, loose or missing gaskets or seals can be a safety hazard.

Keep hose and attachment suction openings away from eyes, ears, mouth and other parts of body.

WARNING

To avoid electric shock: Never vacuum liquids. Never vacuum floors, rugs or carpeting that are wet. Do not store outdoors. Replace worn or frayed power cord immediately.

Do not place or immerse cleaner in water or any other liquids.

Do not reach for cleaner that has fallen into water. Unplug cleaner immediately from the wall socket.

Never handle cord or plug with wet hands.

WARNING

Before servicing, always unplug power cord from wall outlet and be sure motor and fan have come to a complete stop.

Congratulations

on becoming a Kirby owner.

With proper care your Kirby Cleaning System will give you a life-time of service. Because it was designed and built using reliable, high-quality materials.

The Kirby cleaning system gets the cleaning job done faster and easier, leaving more time for yourself or your family.

In the event you require service or information about Kirby attachments and accessories, talk to your authorized independent Kirby distributor or dealer. There's one near you. Check your telephone Yellow Pages.

To fully appreciate the capabilities of the Kirby, please read this **Use and Care Booklet** thoroughly. The information and specifications included here were in effect at the time of printing. The Kirby Company reserves the right, however, to discontinue or change specifications or designs at any time without notice and without incurring any liability whatsoever.

Standard Attachments.

Here are the standard attachments for your Kirby. Each is designed for specific household cleaning jobs. There are detailed instructions for the use of each attachment in later sections of this booklet. Clean each attachment after using and keep brushes free from lint and fibers.



Hose.
Lightweight, flexible, durable, easy-to-use.



Extension Wands.
Lightweight, yet strong. Lock securely together. Contain safety air bleeder holes.



Crevice Tool.
with removable brush. For crevices in furniture without the brush, and for cleaning radiators and other hard-to-dust places with the brush.



Portable Handle With Shoulder Strap.
Makes your Kirby more versatile and easier to use in a variety of places.



Duster Brush.
For end tables, shutters, lamp shades, window moldings, cornices, door jambs, baseboards, books, picture frames, air conditioning and heating duct openings.



Surface Nozzle With Swivel Attachment.
With brush adjustment lever. For cleaning under low objects, such as couches or television consoles.



Utility Brush Nozzle.
For walls, bare floors, ceilings and large, flat, hard surfaces.



Air Intake Guard.
Adapts the Kirby for use with air-powered tools.



Spray Gun.
Use with acrylic or latex based paints, for watering large house plants.

Suds-O-Gun.
For use with Kirby Instant Suds for best upholstery cleaning results.



Inflator/Deflator.
Inflates or deflates toys, air mattresses, other low-pressure inflatables.



Massage Cup.
Use with flexible hose for invigorating skin or scalp massage. Great for pet grooming. Be sure hose is in suction mode. (Attached to front of power plant.)



Utility Air Nozzle.
Used on end of flexible hose for surface cleaning upholstered furniture, fabrics.

VACUUM CLEANER BAGS.

The Kirby Heritage™ features two vacuum cleaner bag systems: the standard disposable filter bag system and the optional reuseable bag system.

Disposable Filter Bag System.

How to change bags.



1. Before you begin, unplug the cleaner's electrical cord from the wall outlet.
2. Unzip the cloth bag at rear of cleaner.

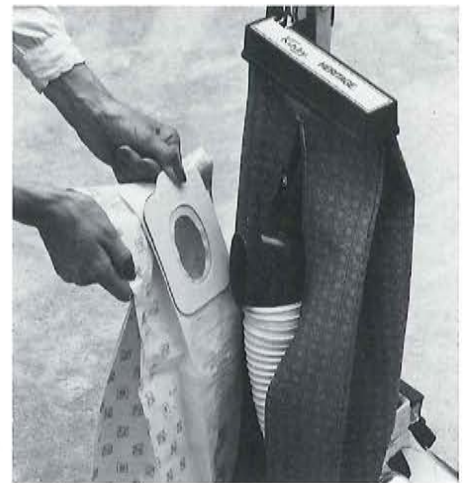

3. To remove used bag, grip the top tab on the cardboard plate, pull back and lift out.
4. To replace, slide new bag into outer cloth bag, making sure the cardboard plate faces the front of the bag.



5. Hold the top tab on the cardboard plate while hooking the bottom of the opening under the lower lip of the bag retainer. Once the bottom is secure, pull the top tab up and over the upper lip of retainer.

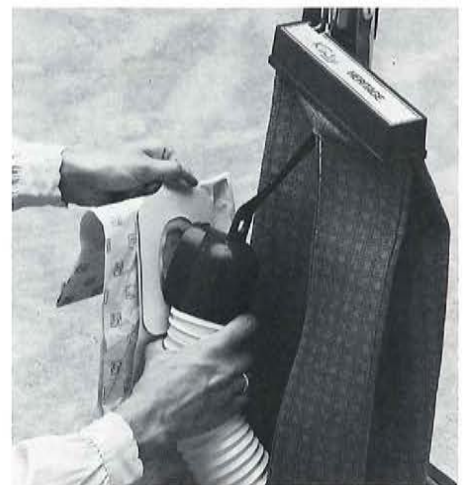

6. Your bag should now be snapped into place — check to make sure the cardboard plate is fully on the bag retainer.
7. Zip the cloth bag closed.

NOTE: When changing the disposable filter bag, empty the **Sani Em-Tor** of any large particles which may have settled there.

For best results: Do not overload bag past the fill tube bag retainer. Never reuse filter bags — this could damage the cleaner. Periodically check to make sure the air passage openings to the filter bag are not blocked.

For peak efficiency and performance, use genuine Kirby replacement parts.

VACUUM CLEANER BAGS.

Reuseable Bag System. (Optional)

The **Sani Em-Tor** and **Sani-Pocket** are patented Kirby features that enable easy and efficient emptying of the reuseable cloth filter bag.

Emptying the Filter Bag.



1. Spread newspaper on the floor and place Kirby on it.
2. Detach wire loop on top end of the bag from handle bracket. Tilt handle back slightly. Push bag top toward handle and lift loop out of bracket.



3. Lower rug nozzle to No. 1 position (as shown) and turn on motor.
4. Allow motor to run briefly and then turn off. While bag is still extended, shake it vigorously from the top.



5. Tilt Kirby slightly and rotate side lever fully to release bottom cover of **Sani Em-Tor**. In the "open" position, the lever will point to the rear of the Kirby.



6. Swing cover out from under **Sani Em-Tor** and turn cover upside down, emptying the dirt and lint onto the paper.
7. After all dirt has been removed, swing cover back into place and lock securely with locking lever. Make sure that cover gasket is free of dirt and that lever handle is fully rotated.



If excessive dirt and lint has accumulated in the bag and does not fall readily into the **Sani Em-Tor**, use the following procedure: Open zipper at rear of bag and place hand inside **Sani-Pocket**, grasping **Sani-Scraper** at bottom.

Scrape sides of bag with **Sani-Scraper** in downward strokes.

Using **Sani-Scraper**, push excess lint and dirt into **Sani Em-Tor**.

Empty as in 5 through 7 above.

CAUTION!
Unplug the cord.

UPRIGHT CLEANER.

Carpet Vacuuming.



Cord Release.

To release cord, turn down the upper cord hook on the handle. Cord will drop free into your hand.



Upright Cleaning.

It's important to have the rug nozzle height set properly to get the most efficient cleaning action. Start out with the Toe-Touch control (30) adjusted to the full up (number 8) position. Then, by pressing your toe downward on the upper part of the Toe-Touch Control, lower the nozzle one step at a time until you notice a change in the sound of the power plant. This indicates that the nozzle is in contact with the rug and ready to clean. Any position lower than this will restrict proper air flow and reduce belt life.



Handle Positions.

When the handle stop latch (28) is pushed to the left, a pin extends. This pin will stop the handle from being lowered to the horizontal. It will lock the handle in the horizontal position for storage, if it is extended with the handle down.

When the pin is out and the handle is upright, pulling back on the handle will cause the front of the machine to tilt up so it can be moved over obstacles such as carpet strips or throw rugs.

UPRIGHT CLEANER.



Sweeping Pattern.

For the best and easiest cleaning action, push the machine straight away from you and pull it straight back. Change the direction of the machine at the end of the pull back and point it in the direction of the next sweeping path. Continue to do this across the entire rug with slow, gliding motions. Do not jerk or tug the cleaner rapidly on back stroke or when changing directions.



Straight Suction Cleaning.

By converting the Kirby upright into a straight suction cleaner, you can easily vacuum bare floors and short pile carpeting.



Converting to a Straight Suction Cleaner.

1. Raise the headlight hood and turn the Belt Lifter (16) fully counter-clockwise. Check the instruction label on top of the rug nozzle to be sure that the belt is disengaged.
2. Lower the headlight hood against the Belt Lifter. With the belt disengaged, the brush roll will not turn and the Kirby becomes a straight suction cleaner.

MATTRESS CLEANER.

It takes just a few steps to convert your Kirby Heritage into hard-working mattress cleaner.

Converting to a Mattress Cleaner.

WARNING

Before changing units or attachments, unplug power cord from wall outlet and be sure motor and fan have stopped.



1. Unhook clip on top (27) of handle. Pull power cord from the bracket on the back of the handle grip. Release it from the handle fork rear cover clips.

WARNING

Failure to disengage brush roll can be hazardous. Keep hair, clothes, buttons, face and fingers away from nozzle.



2. Pull handle pin (12) all the way out and lift handle off the cleaner.



4. Slide Handle Stop Latch (28) fully in direction of arrow to lock portable handle in place.
5. Position bag clip (27) on portable handle as shown.



3. Slide portable handle into the handle channel on the power plant. Push handle pin back in to fasten the portable handle to the power plant. **Be sure pin goes through the holes on both sides of the portable handle.**



6. Raise the headlight hood (19) and turn the Belt Lifter (16) fully counterclockwise. With the belt disengaged the brush roll will not turn and the Kirby becomes a straight suction mattress cleaner.

TANK CANISTER CLEANER.

Attaching the hose.

To use the above-the-floor tools, the flexible hose must be attached to the front of the Kirby.

WARNING

Before changing units and attachments, always unplug power cord from wall outlet and be sure motor and fan have come to a complete stop. Keep hair and loose clothing away from intake ports, nozzle and power plant.

Take extra precautions to assure that hair or loose clothing do not come near intake ports, nozzle, and power plant. Check to see that suction seal ring gasket is not missing in the hose connector. Do not use hose if seal ring gasket is missing or damaged.



1. Move the Toe-Touch Control (30) to the Number 8 position. Then raise headlight hood.



2. Turn the Belt Lifter (16) counter-clockwise, or all the way to the left until it stops. (See instruction label at top of nozzle under the headlight hood.)

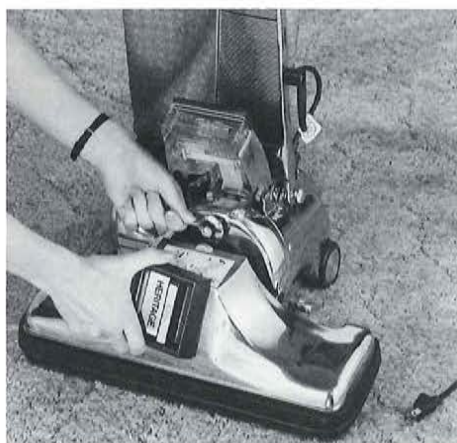

3. Unlock the Accessory Lock (17) that's located under the hood by moving it all the way to the left. Rug nozzle should drop forward slightly.



4. Remove rug nozzle (15) by lifting it up slightly and pulling it toward you. Now you are ready to install the hose.

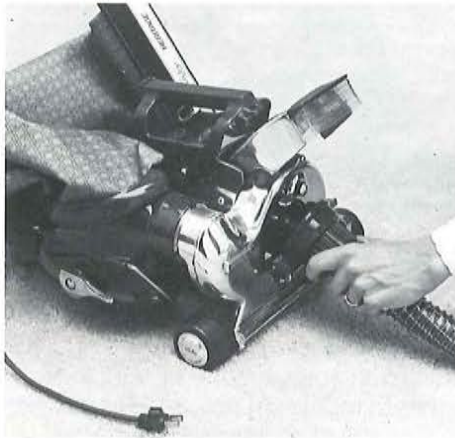

5. Hook the attaching lugs of the large coupling on the flexible hose over the ends of the attaching bar (14) on the power plant and swing the hose coupling end up against the power plant.



6. Rotate the Accessory Lock (17) to the right until hose connector is tightly closed and sealed against power plant. Close the headlight hood.

The Kirby is now ready for above-the-floor cleaning and is ready to accept any of the hose attachments that come with your Kirby.

How to attach tools to the hose.

- 1.** To attach tools, push lightly while twisting the connection of the smaller end of the hose into the desired tool.
- 2.** Extension tubes and swivel elbow are assembled in the same manner. To avoid breakage, do not jam or force the coupling ends into the attachments.



WARNING

Take extra precautions to assure that hair or loose clothing do not come near intake ports, nozzle, and power plant. Check to see that suction seal ring gasket is not missing in the hose connector. Do not use hose if seal ring gasket is missing or damaged.

KIRBY CONVENIENCE GROUP ATTACHMENTS.

WARNING

Before changing units or attachments, unplug power cord from outlet and be sure motor and fan are stopped.



The Crevice Tool.

For deep cleaning in crevices, cracks, corners, grooves, narrow openings and behind seat cushions of upholstered furniture, attach the crevice tool without the removable brush to the flexible hose or to the extension tubes.

With the removable brush placed in the end of the crevice tool, you have a cleaning tool that removes dirt from corners, between radiator coils, venetian blinds and sliding window tracks.



Utility Brush Nozzle.

Attach to end of extension tubes and use for cleaning walls, ceilings and large flat surfaces.

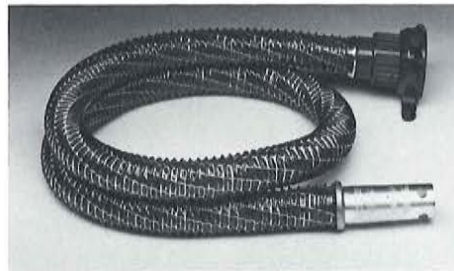

Storing the Flexible Hose.

Never store the flexible hose near a heat source. Keep it in a cool, dry place and never hang it on a sharp hook or nail. Store it in a place where it will be readily available.

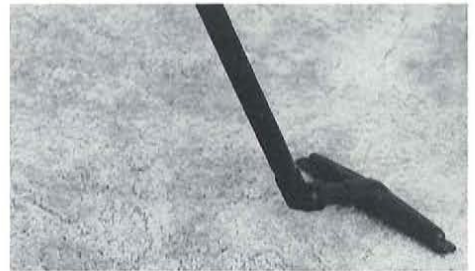

Surface Nozzle with Swivel Attachment.

The surface nozzle with brush extended is for use on carpeted floor areas. It has a lever on the front of its housing which allows you to raise or lower the brush. The up position of the brush is recommended for the cleaning of deep pile or loose throw rugs.



Utility Air Nozzle.

For surface cleaning of upholstered furniture and fabrics.



Inflator/Deflator.

Inflates or deflates toys, air mattresses, other low-pressure inflatables.



Extension Wands.

Attaching the curved extension tube to the hose, the straight extension tube to the curved tube, the swivel tube to the straight tube, and the surface nozzle to the swivel gives you maximum reach.

Attaching the hose to the straight tube and adding the curved extension tube on the straight extension tube and utility brush nozzle makes an effective wall, ceiling and baseboard cleaning arrangement.



The Duster Brush.

Attach the duster brush to the end of the flexible hose or to the extension tubes and you can remove dust from any surface, including those with contours, such as moldings or delicate lamp shades and unusual shapes.



Air Intake Guard.

Adapts your Kirby for use with air-powered tools.



Portable Shoulder Strap.

The shoulder portable is ideal for cleaning in areas where considerable mobility and freedom of hands is required.

Remove the carrying strap from the attachment case and clip the spring clip on each end into the holes at front and back of the portable handle.

Slide the adjusting buckle on the carrying strap so the portable cleaner rests comfortably on your shoulder.

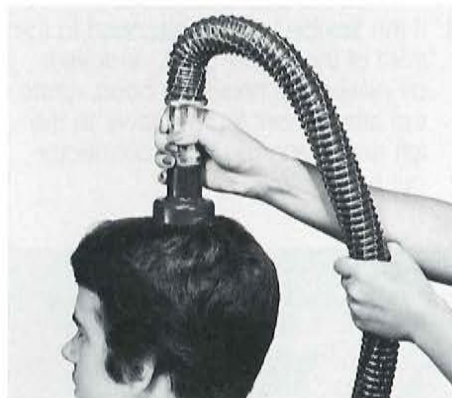

Massage Cup.

Use with flexible hose for invigorating skin or scalp massage. Great for pet grooming.

BLOWER ATTACHMENTS.

Converting for use with blower attachments.

To use the Suds-O-Gun or spray gun or to use the Inflator/Deflator as an inflator, the Kirby must be set up for air pressure driven tools and attachments. This is done by removing the **Sani Em-Tor** from the back of the power plant and replacing it with the flexible hose. The Air Intake Guard is then attached to the intake port on the motor unit.

WARNING

Before changing units and attachments, always unplug power cord from wall outlet and be sure motor and fan have come to a complete stop.



1. Removing the **Sani Em-Tor**. Unhook the filter bag from the handle. Hold the cleaner steady and grasp the **Sani Em-Tor** firmly.



2. To remove the **Sani Em-Tor**, twist up and away from the power plant as far as it will go, then pull straight back. The **Sani Em-Tor** with bag attached will separate from the power plant.

NOTE: The tight seal of the Em-Tor air seal gasket makes it necessary to give a firm, strong tug to twist the **Sani Em-Tor** outward away from the power plant.

Mounting the flexible hose for air blowing. One P.S.I. only (pounds per square inch).



1. If the flexible hose is attached to the front of the power plant, remove it by raising the headlight hood, rotate the attachment locking lever to the left and swing the hose connector out and down.



2. Place the large end of the hose over the air outlet at the back of the power plant. Be sure that the grooves on the inside of the large end of the hose match the lugs on the outside of the power plant outlet.



3. Push the hose onto the air outlet and turn the hose connector in the direction of the arrow in the picture. The hose is now set up for air blowing.



4. Place the attaching lugs of the air intake guard over the attachment bar (#14)* on the power plant. Swing the guard up against the power plant and rotate the accessory lock (#17)* until it is tight. Close the headlight hood.
* Shown on pg. 2.

NOTE: The Kirby cannot be used with air power tools unless the air intake guard or other attachment is latched onto the locking bar over the intake port on the front of the power unit. Check seals and gaskets regularly.

Worn, damaged or missing seals and gaskets could cause a safety hazard and should be kept in good repair or replaced.



The Spray Gun.

Attach spray gun to end of flexible hose.

Unscrew the jar from the spray gun and fill about three-quarters full of the non-flammable liquid to be sprayed. Replace the jar.

Hold the spray gun as nearly horizontal as possible. Turn on the power plant and pull the spray gun trigger. Use slow, sweeping motions.

Turn the spray adjustment clockwise to make the spray finer and counterclockwise to make it coarser.

WARNING

Do not use with flammable or combustible liquids.

When using Latex based or acrylic water based paints, follow the manufacturer's instructions for spraying. Sprayable water based paints must be thinned with water to provide a sprayable consistency.

If the spray gun must be tilted during use, use less liquid in the jar to avoid large droplets in the spray. Clean the gun immediately after use by filling jar with fresh water, spray water with the gun. The air valve in the gun can be removed for cleaning if necessary by turning the air adjusting knob clockwise and disengaging it from the trigger.

Removal of the air adjusting knob enables the valve seat trigger and stem to be removed from the spray gun body for separate cleaning. Reassemble the gun by holding the valve seat in place in the spray gun body while screwing the air adjusting knob clockwise into place.

The spray gun is excellent for watering large leaf house plants with a fine spray, and spray painting with non-flammable paints. **Be sure flammable materials are never used in the gun.**

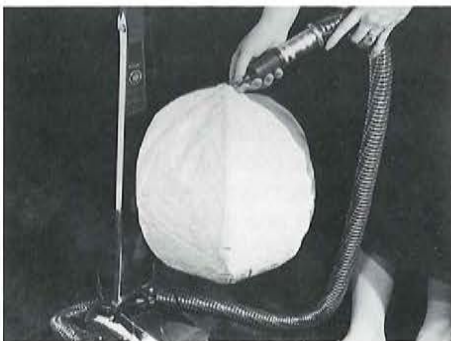

Inflator/Deflator.

With the flexible hose hooked up to the power plant outlet, attaching the inflator/deflator tool to the hose lets you inflate toys, air mattresses or any other low pressure inflatable items up to 1 p.s.i.

CAUTION

Refer to tag on article being inflated for maximum allowable pressure.

BLOWER ATTACHMENTS.

SERVICE TIPS.

Upholstery cleaning with the Suds-O-Gun.

BE CAREFUL. Try a test first on your upholstery. Some fabrics will color bleed or water spot. Some delicate fabrics such as silk, brocade and velvet cannot be shampooed. Apply a small patch of suds from the Suds-O-Gun to an area which does not show. Let it dry, then brush off the residue and observe the results before cleaning the rest of the fabric.



1. Use Kirby Instant Suds (optional) for best upholstery cleaning results. Attach the Suds-O-Gun cap to the end of the spray gun. Attach the hose to the air blowing outlet of the cleaner.



2. Mix Kirby Instant Suds as directed on bottle and fill spray gun jar about three-fourths full. Screw jar tightly onto spray gun and attach gun to end of flexible hose. Adjust spray gun to a very fine spray by turning air adjusting knob at rear of the spray gun clockwise. Turn motor on and pull the trigger. A volume of suds will be produced. Suds can be spread directly on surface to be cleaned, or gathered in a basin or on several thicknesses of plain paper.



3. The suds should be worked into the fabric surface with a soft brush or sponge until they disappear. Allow surface to dry thoroughly and then vacuum with appropriate cleaning tool to remove the dry residue which now contains grime and dirt loosened from the fabric.



4. Standard canning jars with the same screw thread can be used with this gun.

DANGER

Do not use with flammable cleaning fluids.

WARNING

Before changing headlight bulb always unplug power cord from outlet.

Headlight bulb replacement.



1. Raise the headlight hood on the power plant. With a Phillips head screwdriver, loosen the two screws that hold the headlight lens to the hood.



2. Unplug the lens and socket assembly from the terminal block. Replace the bulb, plug in the lens and socket assembly, and replace the screws.

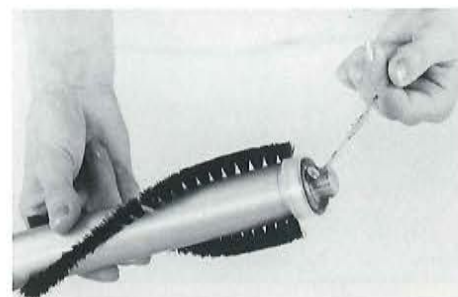

Brush cleaning of Rug Nozzle.

Keep the brushes and belt track clear of lint, string, hair and other fibers. Pay particular attention to keeping these fibers away from the bearings at the ends of the brush roll.

SERVICE TIPS.

Troubleshooting.

Many service calls are unnecessary. Checking a few simple things can save a lot of cost, time and trouble. Whenever your Kirby does not perform properly, make these checks first before calling authorized service personnel.

If the motor does not start when the motor ON-OFF switch is pushed:

1. Make sure the power cord is plugged into an outlet and that the outlet has power. (Check for blown fuses, tripped circuit breaker or power company trouble.)
2. Make sure the cord plug is fully inserted into the cleaner.
3. Look for breaks in the power cord insulation. If the cord is damaged, get a new one. **DO NOT ATTEMPT TO REPAIR IT.**
4. Make sure that an attachment or accessory is properly mounted on the front of the power plant.

If the Kirby does not pick up lint or litter on the carpet:

1. Make sure that the belt is on the brush roll and on the power plant drive pulley.
2. Make sure that the belt is not broken or slipping. Replace if necessary.
3. Check suction seal ring gasket on front of cleaner to see that it's not missing or damaged. Do not use cleaner without a gasket.
4. Check to see that suction seal ring gasket is not missing in the hose connector. Do not use if missing or damaged.
5. Check to see if rug plate on carpet nozzle is properly attached and latched.
6. Make sure that the Toe-Touch control is adjusted to place the nozzle in contact with the rug.

7. Make sure the brush roll is adjusted properly and the bristles are not worn out. 1/16 inch of tuft should extend out of nozzle plate. Check with ruler against nozzle. Replace or adjust as required.
8. Make sure bag is not full.
9. Check to be certain that fill tube and **Sani Em-Tor** are not clogged.

If the Sani Em-Tor is loose:

1. Make sure it is locked in position.
2. Make sure the rubber gasket inside the collar of the **Sani Em-Tor** is properly in place; dirt will blow out if it is not. Replace if the **Sani Em-Tor** gasket is missing or damaged.

If the brush roll in any accessory does not turn:

1. Make sure the belt is not broken or worn out.
2. Make sure the belt is in place around the brush roll and on the power plant pulley.
3. Check to see if brush roll can be rotated.

If the Kirby is hard to push when the rug nozzle is attached:

1. Make sure the nozzle is not set too low. Raise the Toe-Touch control one or two notches.
2. Make sure that the belt is on the brush roll and on the power plant drive pulley.
3. Make sure that the belt is not broken or slipping. Replace if necessary.

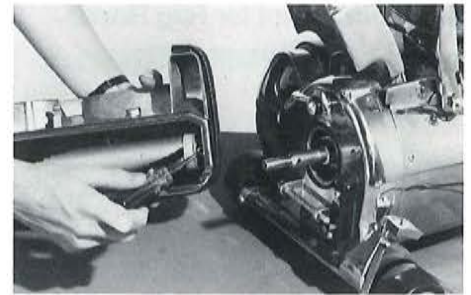

Brush adjustment of Rug Nozzle.

After the rug nozzle has been in use for some time, the brush bristles may begin to wear. To adjust the brush height, place the rug nozzle on a table. Place a straight edge on the nozzle plate next to brush tufts to see protrusion. Turn both screws clockwise an equal amount until the brushes protrude about 1/16 inch past the rug plate. One full turn of these screws moves the brush out about 1/32 inch. Make certain brush roll is kept parallel with rug plate or belt will not center between tufts.

Your Kirby has been designed and manufactured to give you many years of normal in-house usage with relatively little maintenance required.

The Kirby motor has permanently lubricated and sealed ball bearings and will not need lubrication. If bearings become noisy, repair of the motor must be done only by authorized qualified Kirby service personnel.

To maintain your Kirby in good, serviceable condition, it should be inspected periodically by an authorized Kirby service person.

SERVICE TIPS.

Belt replacement for Rug Nozzle.



1. To replace the belt in the rug nozzle, remove the nozzle from the motor and place the nozzle on a table.

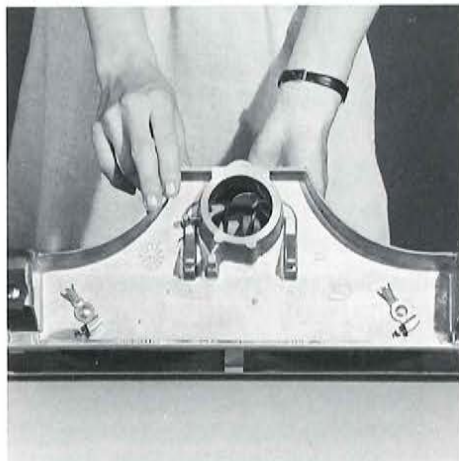

2. Turn the Belt Lifter all the way clockwise until the belt drops off the finger inside the nozzle. Turn nozzle upside down. Unlock rug plate by means of two latches on rear of nozzle.



3. Pull up on rear of rug plate to pull brush roll and plate out of nozzle.



4. Bend slightly one end bracket of the rug plate away from one end of brush.

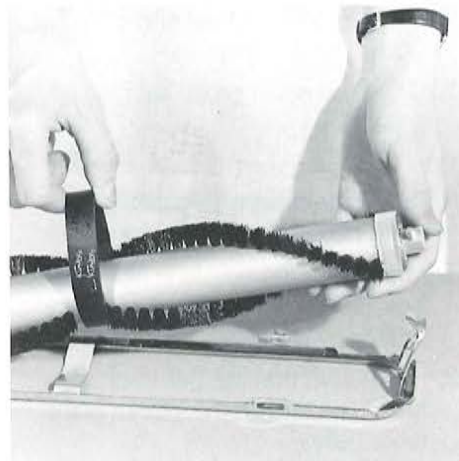

5. Slide the belt off the roll and slide on a new belt. The new belt must be in the middle of the roll. Place the roll back into the end bracket with the screw heads facing the openings in rug plate.



6. Hook rug plate on front of nozzle and rotate it back against nozzle opening and make certain it fully closes against nozzle. Rotate latches to lock plate in place, and center belt under rug plate center rib. Turn the Belt Lifter counter-clockwise until the finger in the nozzle picks up the belt.

NOTE: If the entire roll is removed, be careful to replace the roll exactly as it came out. The silver end of the brush roll is on your left as you face the front of nozzle.

THE RUG RENOVATOR.

The Rug Renovator (optional) is a home carpet cleaning system that works by depositing controlled quantities of suds with very little moisture (dry suds). These suds are worked into the rug by rotary motion of the powered brush as the Rug Renovator is moved back and forth. As it is moved forward, the brush picks up the suds, with dirt and grit, and deposits them in a tray. The slight powdery residue that is left after the rug dries thoroughly contains grit and soil that was too small for the brush to pick up. A simple vacuuming with the Heritage removes this powdery residue and your rug is clean.



Careful Cleaning.

Follow these precautions exactly to get best results.

- Vacuum clean the rug or carpet thoroughly with the upright unit before using the Rug Renovator.
- Test a small area of carpet in a hidden area with the suds and renovator before doing a large area. Some carpet colors bleed and some carpet piles are sensitive to the brushing action when damp.

- Use Kirby Instant Suds rug and upholstery cleaner. This compound is safe for most fabrics. Follow directions on bottle.
- Always store the Rug Renovator nozzle with the tension off the belt.
- Clean the entire Rug Renovator thoroughly after every use according to the instructions to keep it in good working order.

WARNING

Before changing units and attachments, always unplug power cord from outlet and be sure motor and fan are fully stopped. Keep hair and loose clothing away from intake ports, nozzle and power plant.

THE RUG RENOVATOR.

Assembling the Rug Renovator.



1. If the Heritage has been used as a portable, remove the handle pin and lift off the portable handle and carrying strap.



2. Place the long handle in the handle channel on the power plant and insert the handle pin. **Be sure the pin goes through the holes on both sides of the long handle.** Attach the power cord to this handle.



3. Unhook the bag and remove the Sani Em-Tor from rear of power plant by twisting it counterclockwise away from the power plant and pulling back.

Assembling Nozzle and Tray.

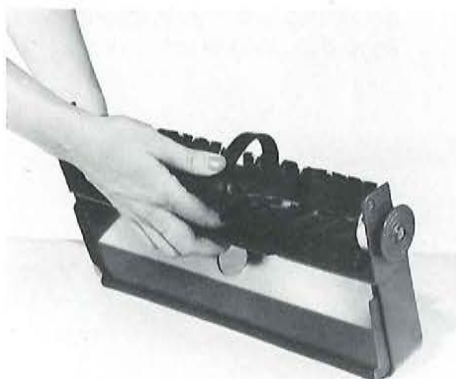

1. Place the nozzle Belt Lifter to the right of the center position. The belt will not be on the lifter when shipped.



2. Slide the grooves on the outside of the Rug Renovator nozzle over the shafts of the bumpers at the ends of the tray. The nozzle will fit onto the tray so that the bumpers are on the outside.

3. Turn over the assembled nozzle and tray and grasp the belt between thumb and forefinger.



4. While pushing up on the belt, turn the Belt Lifter counterclockwise slowly to the stop left of the center position. Make sure the Magic Finger on the inside of the nozzle picks up and holds the belt.

Assembling Nozzle and Tray to Power Plant.



1. Set the Toe-Touch control to the full up (Number 8) position.

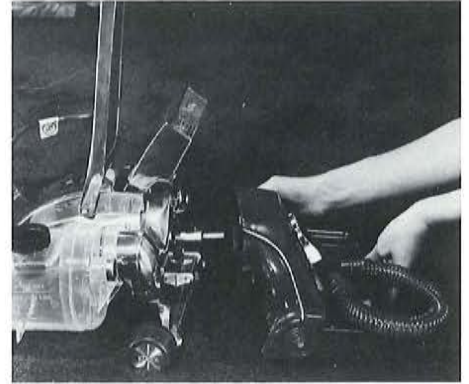

2. With the headlight hood raised and the Accessory Lock rotated all the way to the left, slide the nozzle with tray over the power plant power shaft. Make sure the attaching lugs on the nozzle fit over the attaching bar on the power plant.



3. Twist the nozzle and tray up to the power plant and rotate the Accessory Locking to the right until it locks the nozzle against the power plant.

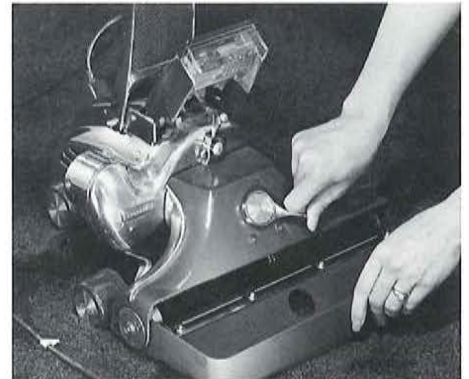

4. Turn the Belt Lifter clockwise to the right position and close the headlight hood.

WARNING

Before changing units and attachments, always unplug power cord from wall outlet and be sure motor and fan have come to a complete stop.

Take extra precautions to assure that hair or loose clothing do not come near intake ports, nozzle, and power plant. Check to see that suction seal ring gasket is not missing in the hose connector. Do not use hose if seal ring gasket is missing or damaged.

THE RUG RENOVATOR.

Installing the Tank and Hose.

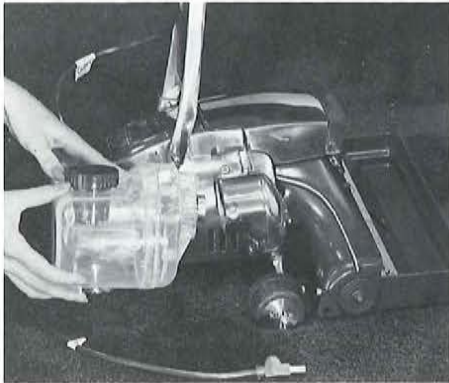

1. Slide the tank over the air outlet at the back of the power plant. Make sure the grooves on the inside of the tank neck fit over the lugs on the air outlet.



2. Twist the tank down and toward the power plant until it locks on the air outlet.



3. Push the straight end of the hose over the tank outlet.



4. Insert the bent end of the hose into the hole in the tray. Make sure the lip on the hose is all the way into the hole.

Filling and Using the Rug Renovator.

WARNING

Unplug cleaner before filling reservoir with water and Instant Suds. Do not overfill. See instructions.



Remove the large cap from the tank. Fill the cap with Kirby Instant Suds. Pour this into the tank and repeat with another capful. This will put a total of four ounces of cleaner in the tank. Do not use more than the recommended amount of suds solution or over-foaming will occur. If a spot is particularly oily or heavily soiled, spray with Kirby Scuttle (optional), let it stand for a few seconds, then lightly scrub with soft bristled brush. Do not use Scuttle in the tank alone. Before assembly to the cleaner, fill the tank with warm water up to the fill line marked on the side. For best results do not mix cleaning fluids.

Replace the cap on the tank.



CAUTION

Do not allow cleaner to stand in one place when motor is running. Suds will build up around cleaner and may wet the carpet severely.

Start motor and immediately move the cleaner back and forth in slow, easy, overlapping strokes. If suds pile up in front of the cleaner, move faster or lower nozzle one notch. If the path of the suds is narrower than the tray, move slower.

One tankful of liquid will clean an area about 9 feet by 12 feet. If your rug is larger, clean out the tray and refill the tank with suds mixture.



Adjusting Renovator.

To adjust the Rug Renovator to the proper height for shampooing your rug or carpeting, depress the Toe-Touch control lever as far as it will go. This raises the Rug Renovator to its maximum height. Lower the Rug Renovator a step at a time by depressing the Toe-Touch control as many times as is necessary until the brush roll will just start to rub on the carpet as you move the Kirby back and forth.



When the rug has thoroughly dried after cleaning, vacuum the slight powdery residue with the Kirby assembled as an upright cleaner.

THE RUG RENOVATOR.

Spot Scrubbing..

If it becomes necessary to stop the Rug Renovator's suds at any point to scrub one area of the rug that is badly soiled, follow these steps.



1. Turn motor off. Disconnect the Rug Renovator hose from the tank and place a small piece of plastic food wrap over the suds screen outlet.



2. Push the hose and back over the suds screen outlet and plastic wrap to prevent suds flow. Turn motor back on.



3. When spot scrubbing is complete, remove the plastic wrap and continue cleaning in the normal manner.

Cleaning the Rug Renovator.

WARNING

Before changing units or attachments, always unplug power cord from wall outlet and be sure motor and fan have come to a complete stop.

1. Raise the Toe-Touch height adjustment to the full up position.
2. Remove the hose from the tank, but not from the tray.
3. Raise the headlight hood.
4. Rotate the Belt Lifter counterclockwise to raise belt off of pulley shaft.
5. Turn the Accessory Lock all the way to the left.
6. Lift the nozzle with tray up off the attaching bar. Carry to sink. Hold level to prevent spilling.
7. Turn the Belt Lifter to the right to remove the belt from the Belt Lifter.
8. Pull the tray and nozzle apart.
9. Rinse off tray, hose and brush.
10. Rinse off nozzle and any suds collected behind the fixed shield.
11. Remove the hose from the tray and rinse out the hose.
12. Dry the tray, hose and nozzle.
13. Remove the tank from the air outlet by twisting counterclockwise away from the power plant and pulling back off the cleaner.
14. Remove the suds screen and cap and sponge filter and clean them thoroughly. Rinse out the tank and replace the screen cap and filter.

With a small Phillips head screwdriver, loosen one of the bumpers on the tray and remove the other one. Raise the brush roll out of the tray carefully so as not to bend the roll axle.

Slide off the old belt and slide on a new one. Drop the brush roll back into the tray, replace the bumper, and tighten both bumpers. Make sure the belt is in the middle of the brush roll.

THE FLOOR POLISHER & CARPET FLUFFER.*

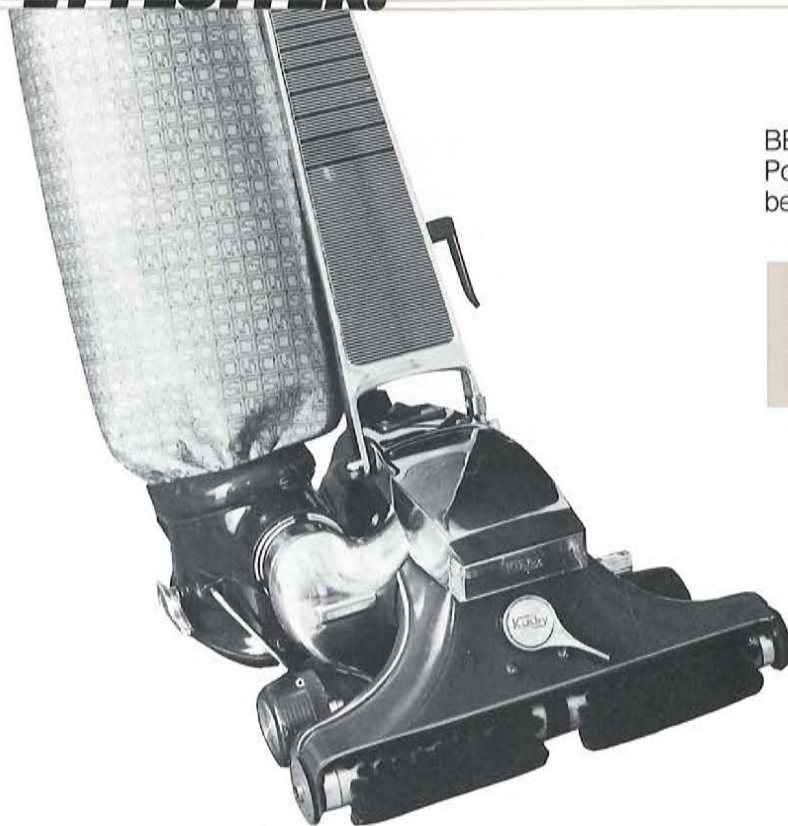

BE CAREFUL. Always store the Floor Polisher and Carpet Fluffer so that the belt is under no tension.

WARNING

Do not use with flammable or combustible liquids to polish or clean floors.

Follow these steps to assemble:

1. Place the nozzle Belt Lifter to the right of the center position.
2. Slide the grooves on the outside of the Rug Renovation nozzle over the shaft inside the bumpers of the Floor Polisher & Carpet Fluffer brush roll.
3. Turn over the assembled nozzle and brush roll, grasp the belt, and turn the Belt Lifter counterclockwise slowly to the stop left of the center position. Make sure the Magic Finger on the inside of the nozzle picks up and holds the belt.

***Rug Renovator nozzle required for operation**



THE FLOOR POLISHER & CARPET FLUFFER.*

WARNING

Before changing units and attachments, always unplug power cord from wall outlet and be sure motor and fan have come to a complete stop. Keep hair and loose clothing away from intake ports, nozzle and power plant.

Mounting the Floor Polisher & Carpet Fluffer.



1. Lift the headlight hood of the Kirby and remove any attachment currently on power plant.



2. With the Belt Lifter to the left of center position, slide the Floor Polisher & Carpet Fluffer over the power plant shaft and engage the attaching lugs on the attaching bar.



3. Swing the Floor Polisher & Carpet Fluffer up to the power plant and rotate the Accessory Lock until it is tight.



4. Turn the Belt Lifter clockwise to the other stop on the right of center position to settle the belt on the shaft.

5. Close the headlight hood.



Using the Floor Polisher.

Set the Toe-Touch control to the Number 1 (down) position. BE CAREFUL. When you start the power plant motor, the powerful Floor Polisher will tend to pull the Kirby away from your hand. HOLD ON TIGHTLY to the handle.

Move the Kirby with Floor Polisher over the waxed floor with the handle in normal operating position. Very quickly a beautiful, lasting wax glow will appear. If a baseboard or other vertical surface must be polished, turn cleaner off, then move the handle forward and push the handle stop latch control to the left. Then you can tilt the brush up a vertical surface by simply pushing down on the handle as it rests against this pin with rear wheels on the floor.



The Carpet Fluffer.

Use clean Rug Fluffer to raise or fluff the nap on rugs or carpeting. Start by lowering the Toe-Touch Control until cleaner starts to move forward on its own. Hold handle grip firmly. Now your Kirby is set at the correct level to restore your rugs and carpeting to their original new look.

Care of the Floor Polisher and Carpet Fluffer Cleaning.

Keep wax buildup off the housing. Wipe clean with a soft cloth after each polishing job. Cut string and lint buildup away from brush. Do not wash brush, but wipe clean with a coarse cloth.



Belt Replacement.

Remove nozzle from cleaner. Rotate the Belt Lifter clockwise to the right stop. Remove the brush and attached bumpers from the Rug Renovator nozzle slots. Push a new belt to the center section of the roller.

1. Place the end slots of the Rug Renovator nozzle over the shaft of the Brush Roll bumpers.
2. Grasp the belt between two fingers and push it up against roll.
3. While holding belt up, turn the Belt Lifter counterclockwise. The Belt Lifter finger will pick up the belt.

***Rug Renovator nozzle required for operation**

TURBO BRUSH.

CAUTION. When using the Turbo Brush, keep it moving across the surface to be cleaned. Do not let it remain in one place.

For maximum cleaning efficiency, keep base plate of Turbo Brush level with the surface being cleaned. The rotating brush may cause particles to be thrown from rear of base plate if not held level. To reduce suction when vacuuming draperies, clothing, etc., open slide valve. Do not insert fingers in open slide valve.

WARNING

Before changing units or attachments, unplug power cord from wall outlet and be sure motor and fan have stopped.

WARNING

Remove Turbo Brush from unit before servicing.



Turbo Brush. Ideal for deep cleaning of carpeting and stair treads, as shown.



This unique portable cleaner makes difficult hand vacuuming jobs easy. Turbo Brush uses a mechanical brushing action to do a thorough cleaning job on carpeted stairs, upholstery, drapes — anywhere an upright cleaner can't be used.

Belt replacement for Turbo Brush.



Remove base plate by sliding bottom latch back and belt cover by removing screw. Next, remove belt from pulley (may help to turn brush backwards slightly). Pull belt and brush assembly out and replace belt. Before replacing base plate and belt cover, make sure

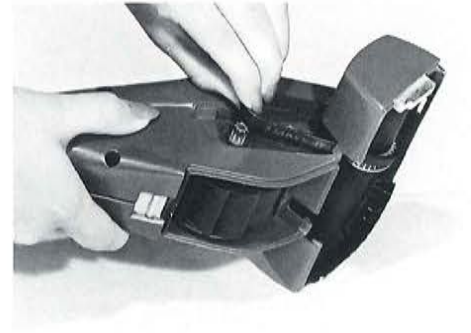

a "2" is showing at both ends of brush roll assembly, and no brush bristles are caught between the belt and brush roll gear. If brush roll bristles are worn, see brush adjustment instructions on page 17.

THE TURBO SANDER.

The Kirby Turbo Sander is a rugged, yet extremely lightweight orbital sander — a high-quality power tool built of the very finest materials available.

Designed to operate at 8,000 to 12,000 RPM, the air-powered Turbo Sander is ideal for a wide variety of sanding, scrubbing and polishing duties. Attach the special massage pad, and it even brings relief to tired, aching muscles.

On top of all that, the Turbo Sander's dust shroud enables it to pick up a high percentage of the dust created by sanding, making it the cleanest orbital sander on the market.

It also may be the simplest and most convenient to use. The vacuum hose from your Kirby plugs directly into the sander — no special adaptor is needed. No special sandpaper is needed, either. The Turbo Sander will accept any standard one-third sheet size sandpaper.

Using the Turbo Sander.



1. Move the Toe-Touch control to the Number 8 position and raise the headlight hood.
2. Turn the Belt Lifter counterclockwise until it stops. Follow the instructions on the nozzle.
3. Unlock the Accessory Lock and remove the rug nozzle (or other attachment) from the front of your Kirby.

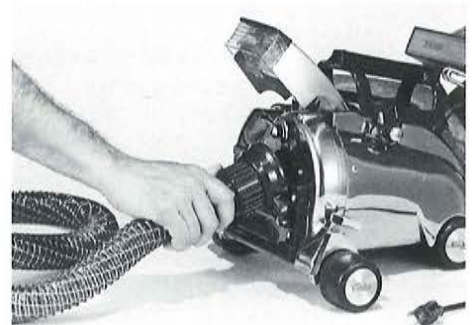

4. Hook the attaching lugs of the flexible hose coupling over the ends of the attaching bar on the power plant and then swing the hose coupling end up against the power plant.
5. Rotate the Accessory Lock until the hose connection is tightly closed and sealed against the power plant. Lower the headlight hood.



6. Attach the sander to the hose.

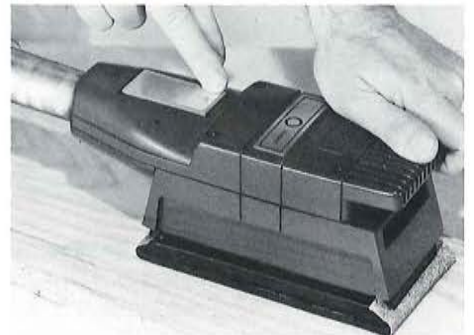

7. Turn your Kirby on and then move the sander handle switch to the ON position.

WARNING

Before changing units or attachments, unplug power cord from wall outlet and be sure motor and fan have stopped.

THE TURBO SANDER.

WARNING

Do not use the Turbo Sander for removing solvent-based materials. Before using the sander, make sure that all metal protrusions (nails, tacks, etc.) are below or removed from the surface to be sanded. Contact with metal objects could result in dangerous sparks, and could damage the sander pad.

Empty or replace the Kirby filter bag after each use of the Turbo Sander. Do not store the Kirby with sanding dust in the bag as it may contain combustible materials. Do not smoke while emptying the bag.

Secure your work with clamps or a vise. This is not only safer, but also frees both of your hands to operate the sander.

Because the scrubbing pad often is used in conjunction with water and/or Scuttle, do not use it with the dust shroud in place and do not block the front air-intake ports. Fluids could be vacuumed up into your Kirby, creating a dangerous shock hazard.

WARNING

The Turbo Sander's massage pad is intended for use where massage is desirable or medically recommended. Do not use it on the abdomen when pain is present. Do not use it on swollen or inflamed areas, skin eruptions, legs with varicose veins, unexplained calf pains or anesthetic skin areas unless approved by your physician. Use by children or debilitated people should be supervised by adults.

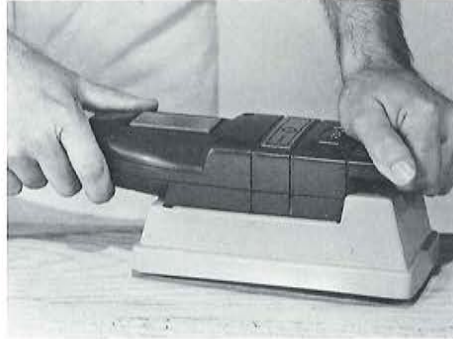

When sanding wood surfaces, be sure to choose the right grade of paper for the job at hand. Coarse paper will remove material faster; fine paper will result in a smoother surface. (Note the position of the hands: this is the correct grip. Also, take care not to force the tool — let it do the work. The Turbo Sander will do a better and safer job when it is allowed to operate at the rate for which it was designed.)

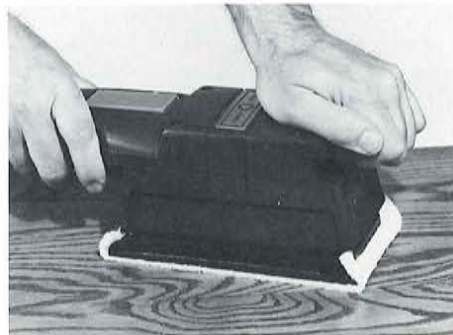

The polishing pad is ideal for buffing furniture wax to a lustrous sheen, or for polishing shoes. Do not use the dust shroud with this pad.

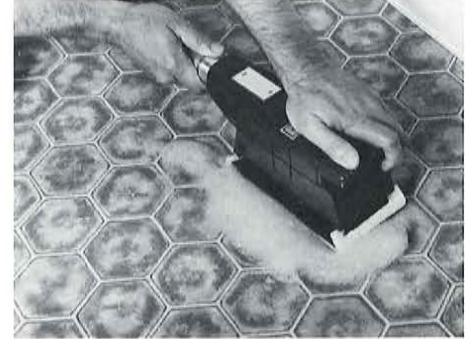

The scrubbing pad works well for the scratch free cleaning of hard surfaces such as porcelain and ceramic tile. To remove stubborn stains, apply a little Scuttle all-purpose cleaner directly to the stain before scrubbing. Use light pressure. Do not use dust shroud with this pad. Use only as directed on hard surfaces. Do not use on porous materials such as linoleum or coated surfaces such as enameled stoves, refrigerators, etc.



Relieve tired, aching muscles with the Turbo Sander's exclusive massage pad. Do not use the dust shroud with this pad.

Loading the sandpaper.

NOTE: Follow the first four steps when installing the scrubbing, polishing or massage pad. Do not use the dust shroud with these pads.



1. Unsnap the dust shroud and remove it from the sander.
2. Snap both sandpaper clamps up.

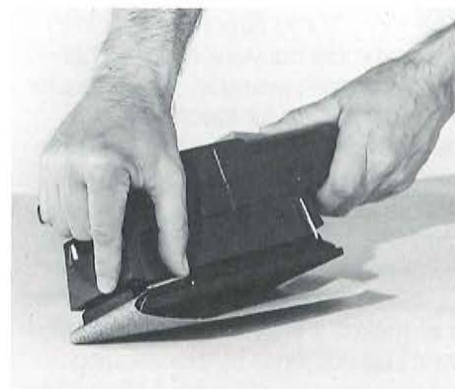

3. Load paper in the front end of the sander first. Then snap down the front clamp.

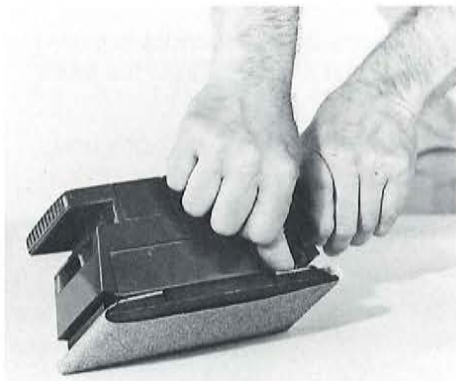

4. Load paper in the rear end of the sander and snap down the rear clamp.
5. Place the dust shroud in position (see following instructions) and snap it in place. The paper should be tight.



Attaching the dust shroud.

The Turbo Sander will operate well with or without the dust pick-up shroud. However, most people prefer to use it with the shroud in place because the sander will then remove almost all of its own dust. To attach the shroud:

1. Wrap it around the sander, keeping the open end of the shroud to the rear of the sander.
2. Snap it closed. Make sure the shroud sides are properly engaged.

THE TURBO GROOM.

The Kirby Turbo Groom is the cleanest and most convenient home barbering system available. It's perfect for the kids' hair, or for touch-ups between trips to the barber. As it cuts hair, the Turbo Groom automatically vacuums up the clippings, removing them before they can fall to the floor — or down the back.

It's made of lightweight material that makes it easy to handle. And you won't be bothered by the fatiguing vibration or excessive heat often generated by conventional electric clippers. The smooth, powerful turbine motor and the hair-removing jet stream both operate on the air power provided by your Kirby.

The Turbo Groom's simple, sturdy construction enables it to give years of reliable service with very little care: a) Before each use, and before starting, apply one drop of oil to both sides of clipper blades; b) To obtain full turbo power, change or empty Kirby filter bag as required and c) Periodically, snap off the top cover and brush out any hair in the mechanism.

WARNING

Before changing units or attachments, unplug power cord from wall outlet and be sure motor and fan have stopped.

Using the Turbo Groom.

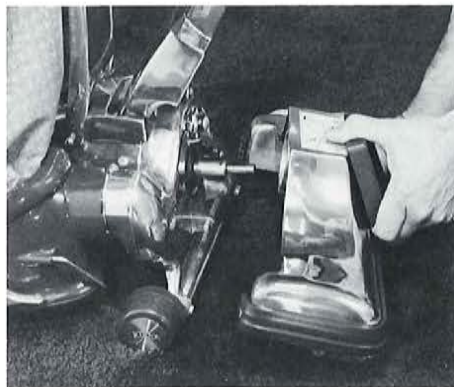

1. Move the Toe-Touch control to the Number 8 position and raise the headlight hood.
2. Turn the Belt Lifter counterclockwise until it stops. Follow the label on top of nozzle.
3. Unlock the Accessory Lock and remove the rug nozzle (or other accessory) from the front of your Kirby.



6. Attach the hose from the Turbo Groom to the flexible hose from your Kirby.



4. Hook the attaching lugs of the flexible hose coupling over the ends of the attaching bar on the power plant and then swing the hose coupling up against the power plant.
5. Rotate the Accessory Lock until the hose connection is tightly closed and sealed against the power plant. Lower the headlight hood.



7. Turn your Kirby on.

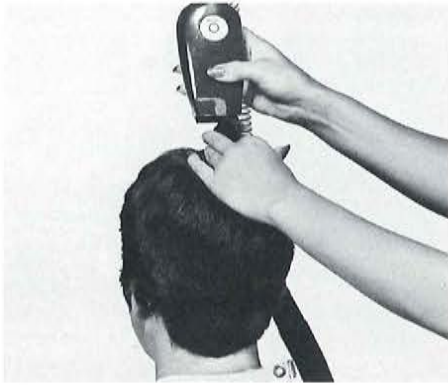

The simplest way to trim hair is to hold strands in such a way that the amount you wish to cut off extends beyond your first and second fingers. Then shear it off with the clippers.



For tapering the back of a head with very short hair, use the "Trim" guide.



For tapering very short hair on the sides, use the "Medium" guide.

For very short (1/2 inch) hair on top, use the "Long" guide.



Connect the massage cup to the accessory hose and move it through the hair for an invigorating scalp massage.

THE TURBO GROOM.

Attaching the trimming guides.



Simply slide the front edge of the cutting blades into the guide.

Cleaning the clipper and hose.

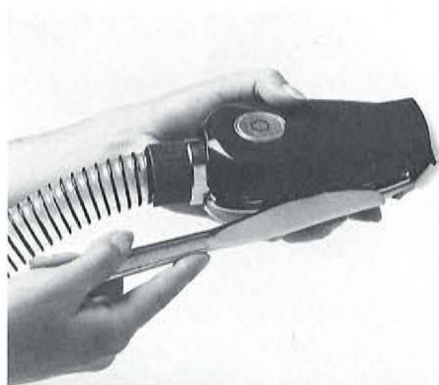

1. To clean the Turbo Groom's internal passage, snap off the top cover with a dinner knife, remove any hair with a brush, and snap the cover back on.



2. To clean the hose, simply flush it with a water/detergent solution.

NOTE: Do not clean the Turbo Groom while it is attached to the flexible hose.

Blade care.



1. Before using the Turbo Groom, apply one drop of oil to each side of the clipper blades.

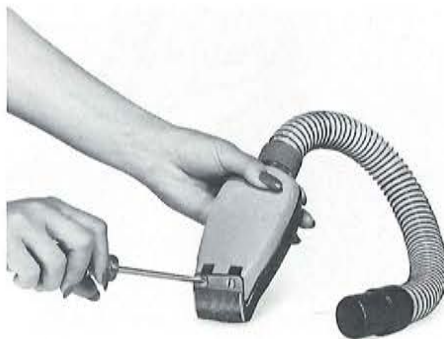

2. From time to time, the blades will need to be cleaned. To do so, simply remove them from the Turbo Groom (they are held in place by two screws) and wash them in a water/detergent solution.



NOTE: When replacing the blades, allow the cutting edge of the lower blade to protrude 1/32" beyond the upper one. Before using the Turbo Groom again, apply a drop of oil to each side of the blades.

LIMITED WARRANTY.

The sign of Kirby quality.

Whenever you require service or desire to purchase one of the many accessories available for your Kirby Heritage™, look for this sign of the Authorized Kirby Distributor. You'll find it on his store front and in your telephone Yellow Pages. It's your assurance of qualified service and expert assistance.



Owner Registration.

To register for your Kirby Rebuilding Agreement, please complete the Owner Registration card that is packaged with your cleaner. To insure proper registration, check to see that the serial number on your cleaner corresponds with the number on the card.

Important Notice.

The Kirby Company provides a valuable rebuilding service for the owner of a Kirby purchased from an Authorized Kirby Distributor, when the unit is purchased for personal, family, or household use. To register for that service, make sure that your Rebuilding Agreement Card has been properly filled out and signed by the salesperson at the time of sale, and a copy has been left with you. Keep that card in a safe place.

THE SERIAL NUMBER ON YOUR MACHINE SHOULD MATCH THE SERIAL NUMBER AT THE UPPER RIGHT CORNER OF THE CARD.

That Kirby Rebuilding Agreement, and the Limited Warranty which is described on the opposite page, are each null and void if the name plate or serial number of the Kirby has been defaced, removed, or changed (other than by fire or other casualty or accident, or in connection with the factory rebuild) and the Kirby Rebuilding Agreement is null and void if the Kirby was not purchased from an independent authorized Kirby distributor or dealer who signed the Rebuilding Agreement Card and filled in the date and serial number.

PROTECT YOUR RIGHTS: IN ORDER TO ASSURE THE VALIDITY OF YOUR REBUILDING AGREEMENT, MAKE SURE YOU ARE

1. PURCHASING FROM AN INDEPENDENT AUTHORIZED KIRBY DISTRIBUTOR OR DEALER;
2. THE REBUILDING AGREEMENT CARD IS FILLED IN AND SIGNED;
3. THE ORIGINAL NAME PLATE AND SERIAL NUMBER ARE INTACT.

Subject to the conditions and exceptions stated below, The Kirby Company ("Company") warrants to the original purchaser (OTHER THAN FOR PURPOSES OF RE-SALE) that each Kirby product shall be free from defects in material and workmanship, under normal use and service, as follows: (a) for two (2) years from the date of purchase by the original purchaser when used for personal, family, or household purposes ("consumer purposes"); (b) for one (1) year from the date of purchase by the original purchaser when used for commercial, professional, rental, institutional, etc., purposes ("commercial purposes"); (c) for one (1) year from the date of any factory repair or rebuild provided to the original purchaser under the terms and condition of the KIRBY REBUILDING AGREEMENT. During the applicable warranty period, the Company will furnish for the Kirby product a replacement part for any part found to be defective, through an authorized Kirby Distributor. All transportation expenses must be borne by the purchaser. This Limited Warranty does not apply to motor brushes, belts, light bulbs or other expendables, such as buffing pads, compounds, etc., charges for labor or service calls, damage caused by accident, misuse, negligence, abuse, or to any Kirby product which has been repaired so as in the judgment of the Company to affect its stability or reliability, or in which parts not approved by the Company shall have been used.

The foregoing provisions state the exclusive remedy for any breach of warranty or any other claim in respect of any Kirby product. THERE IS NO OTHER EXPRESS WARRANTY. IMPLIED WARRANTIES, INCLUDING THOSE OF MERCHANTABILITY AND FITNESS FOR A PARTICULAR PURPOSE ARE LIMITED TO TWO (2) YEARS FROM THE DATE OF PURCHASE BY THE ORIGINAL PURCHASER, IN THE CASE OF KIRBY PRODUCTS USED FOR CONSUMER PURPOSES; TO ONE (1) YEAR FROM THE DATE OF ANY FACTORY REBUILD PROVIDED TO THE ORIGINAL PURCHASER UNDER THE TERMS AND CONDITIONS OF THE KIRBY REBUILD AGREEMENT; AND TO ONE (1) YEAR FROM THE DATE OF PURCHASE BY THE ORIGINAL PURCHASER, IN THE

CASE OF KIRBY PRODUCTS USED FOR COMMERCIAL PURPOSES; AND ANY IMPLIED WARRANTY OF FITNESS FOR COMMERCIAL USE IS HEREBY DISCLAIMED. THIS IS THE EXCLUSIVE REMEDY, AND ANY LIABILITY FOR INDIRECT OR CONSEQUENTIAL DAMAGES OR FOR ANY INCIDENTAL EXPENSES, IS EXCLUDED. Some states do not allow limitations on how long an implied warranty lasts, or do not allow the exclusion or limitation of incidental or consequential damages, so the above limitations may not apply to you.

The Company neither assumes or authorizes any other person to assume for it, any additional liability in connection with the sale of its products.

THE LIMITED WARRANTY IS NULL AND VOID IF THE NAME PLATE OR SERIAL NUMBER OF THE KIRBY HAS BEEN DEFACTED, REMOVED, OR CHANGED (OTHER THAN BY FIRE OR OTHER CASUALTY OR ACCIDENT, OR IN CONNECTION WITH A FACTORY AUTHORIZED REBUILD).

This Limited Warranty gives you specific legal rights, and you may also have other rights which vary from state to state.

Service calls and labor costs, including those during the warranty period, will be at the expense of the owner.



Other Fine Kirby Products.



Scuttle. Makes cleaning as easy as spray on-wipe off. Perfect for windows, walls, chrome, woodwork, stainless steel, appliances, almost any washable surface.

Room and Carpet Home

Freshener. Fast-working powered room freshener sprinkles on carpet — vacuums up in seconds. Delightful lemon scent.

Handi-Waxer and Wax.

An efficient floor waxer used to apply Kirby Handi-Waxer wax. Uses extension wands from the Kirby cleaner for a handle. Handi-Waxer wax brings a lustrous, deep-gloss shine to tile, linoleum, vinyl, many other floor surfaces. Specially formulated for use with the Handi-Waxer.

Odorific. All-purpose deodorizer eliminates household odors instantly, economically up to 24 hours with only a drop.

Instant Suds. A product with a combination of cleaning power, resoiling resistance and fabric brightener makes

it an outstanding rug and upholstery shampoo.

Touch-up Paint. A special touch-up paint that will keep the finish of your Kirby looking like new. Packaged in a convenient 3-pack.

Replacement Belts. Kirby replacement belts for your rug nozzle and Turbo-Brush to keep your system operating at peak efficiency.

Disposable Filter Bags. These bags are a must for your Kirby disposable bag cleaning system. Packaged in 3 and 12 packs.

WARNING.

Please keep these products out of the reach of children. May cause irritation if swallowed or placed in eyes.

Kirby Care Kit.

Kit includes everything needed to remove common spots and stains from upholstered furniture and carpets.



a Scott Petzer company

Cleveland, Ohio 44102 U.S.A.